

Click to
ORDER
samples

AMSRI-78-EZ



The AMSRI-78-EZ series are SIP3 DC/DC high efficiency switching regulators and ideal substitutes for LM78xx series three-terminal linear regulators. The switching regulators feature high efficiency, low loss, short circuit protection, and there is no need for a heat sink.

It also features excellent reliability and performance while offering a wide input voltage range of 4.75-36VDC as well as an output voltage of -15~15V. This compact SIP3 design will surely benefit your new system design.

This new series offers great operating temperatures, from -40 to 85°C with full power up to 71°C. Additionally, 5,000,000 hours MTBF comes standard.

The AMSRI-78-EZ is suitable for instrumentation, industrial control and electric power.

Features

- Pin-out compatible with LM78XX Linear
- Non isolated, heatsinks not required
- Efficiency up to 95%
- Operating Temp: -40 °C to +85 °C
- Short circuit protection: Continuous, Auto recovery
- No-load input current as low as 0.3mA
- Regulated output
- Made in Taiwan



Summary

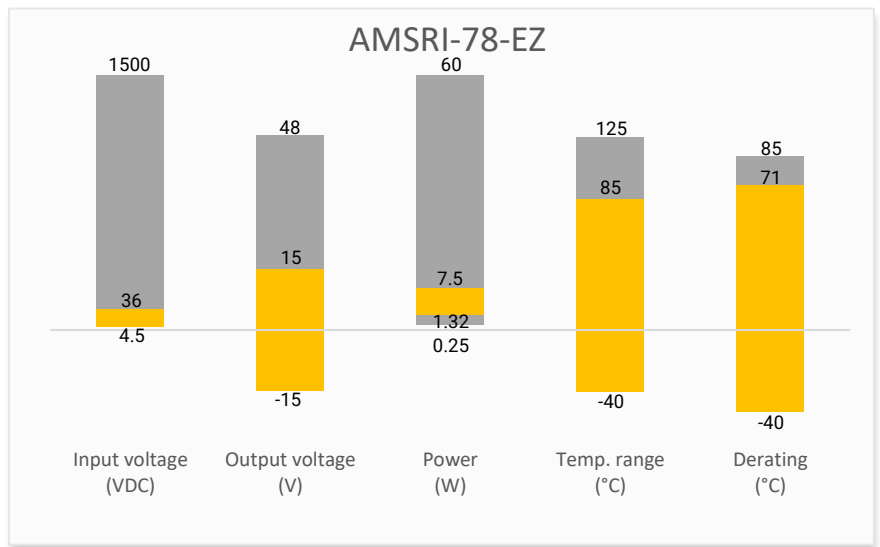

Training



Applications



Models & Specifications



Model	Input Voltage (VDC)	Output Voltage (VDC)	Output Current max (mA)	Maximum capacitive Load (μF)	Efficiency Vin Min (%)	Efficiency Vin Max (%)
AMSRI-783.3-EZ	4.75-36	3.3	500	1000	90	78
	4.75-25	-3.3	-400	470	75	78
AMSRI-7805-EZ	6.5-36	5	500	1000	92	84
	6.5-27	-5	-500	470	78	83
AMSRI-7809-EZ	12-36	9	500	1000	95	90
	7-23	-9	-200	470	85	86
AMSRI-7812-EZ	15-36	12	500	1000	95	92
	7-20	-12	-200	470	83	87
AMSRI-7815-EZ	18-36	15	500	1000	95	93
	7-18	-15	-200	470	81	87

Output Specification

Parameters	Conditions	Typical	Maximum	Units
Voltage accuracy	100% load	2	±3	%
Line regulation	100% load		0.3	%
Load regulation	10-100% load	0.4	0.6	%
Ripple & Noise*	3.3/5 Vout models		75	mV pk-pk
	Others		100	mV pk-pk
Transient response	50% load step change	250		μS

* Ripple and Noise are measured at 20MHz bandwidth. Please refer to the application note for specific detail.

General Specifications

Parameters	Conditions	Typical	Maximum	Units
Switching frequency	Full load, nominal input	440		KHz
Short circuit protection	Continuous, auto recovery			
Operating temperature	With derating at 71°C	-40 to +85		°C
Storage temperature		-55 to +125		°C
Cooling	Free air convection			
Humidity	Non-condensing		95	% RH
Case material	Black plastic (flammability to UL 94V-0)			
Weight		2		g
Dimensions (L x W x H)		0.46 x 0.30 x 0.41 inches (11.60 x 7.60 x 10.40 mm)		
MTBF	5 000 000 hrs (MIL-HDBK -217F, t=+25°C) / Full Load			

NOTE: All specifications in this datasheet are measured at an ambient temperature of 25°C, humidity<75%, nominal input voltage and at rated output load unless otherwise specified.

Safety Specifications

Parameters		
Standards	EMC - Conducted and radiated emission	CISPR32 / EN55032, class B with the recommended EMI circuit
	Electrostatic Discharge Immunity	IEC/EN 61000-4-2 Contact ±4KV, Criteria B
	RF, Electromagnetic Field Immunity	IEC/EN 61000-4-3 10V/m, Criteria A
	Electrical Fast Transient/Burst Immunity	IEC/EN 61000-4-4 ±1KV, Criteria B
	Surge Immunity	IEC/EN 61000-4-5 L-L ±1KV, Criteria B
	RF, Conducted Disturbance Immunity	IEC/EN 61000-4-6 3Vr.m.s, Criteria A

Derating

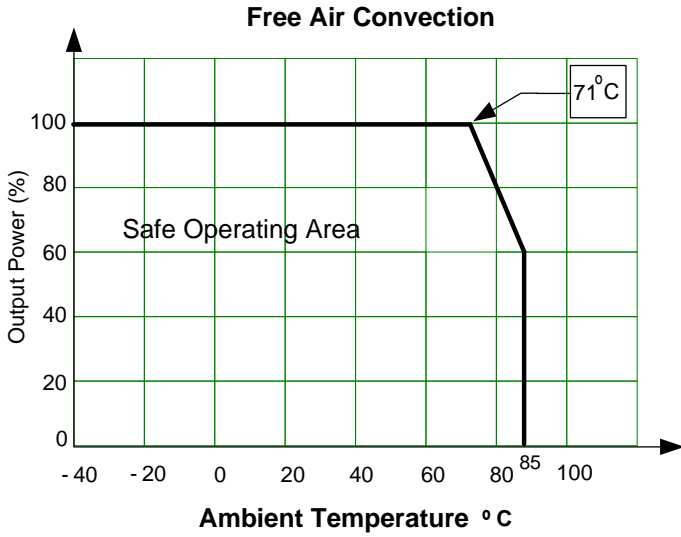

Typical application circuit



Standard Application circuit – positive output

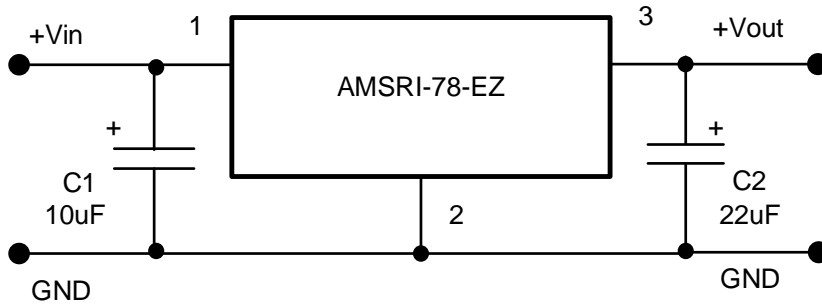

Standard Application circuit – negative output

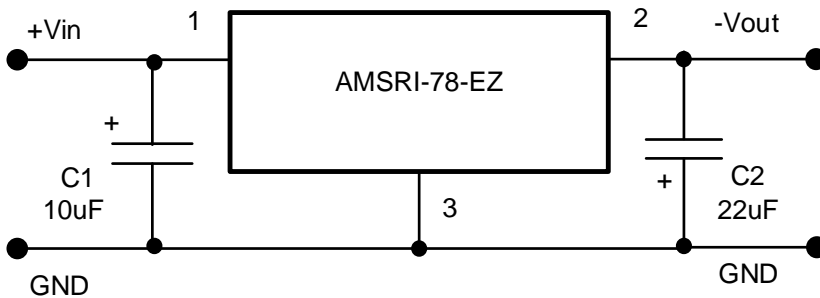

EMI Recommended circuit

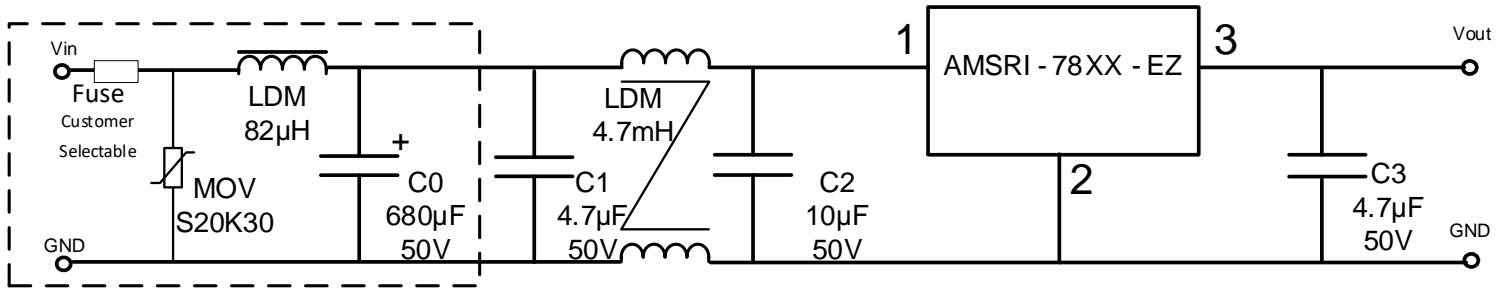

Dimensions

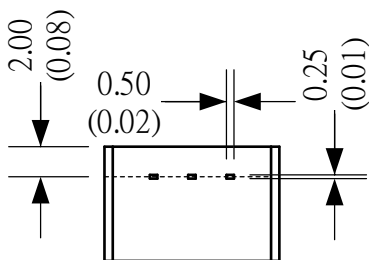
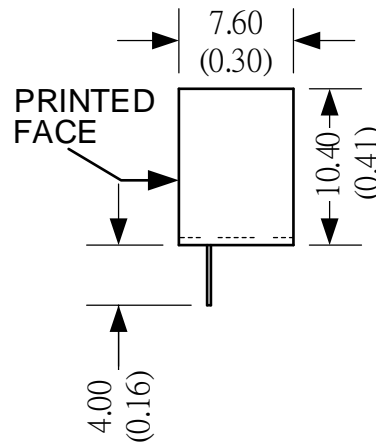
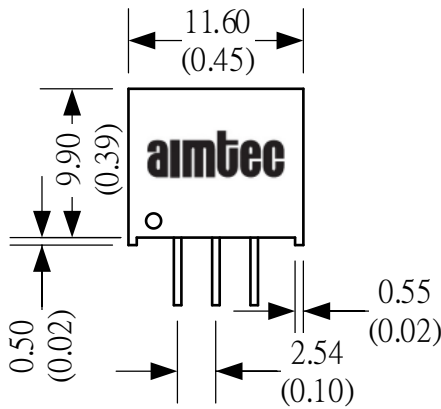

Dimensions are in mm (inch)
Pin Tolerance : ± 0.05 mm (0.002 inch)
Pin Distance : ± 0.25 mm (0.01 inch)
Case Tolerance : ± 0.50 mm (0.02 inch)

Pin Out Specifications

Pin	Single
1	+V Input
2	Ground
3	+V Output

NOTE: 1. Datasheets are updated as needed and as such, specifications are subject to change without notice. Once printed or downloaded, datasheets are no longer controlled by Aimtec; refer to www.aimtec.com for the most current product specifications. 2. Product label shown, including safety agency certifications on label, may vary based on the date manufactured. 3. Mechanical drawings and specifications are for reference only. 4. All specifications are measured at an ambient temperature of 25°C, humidity < 75%, nominal input voltage and at rated output load unless otherwise specified. 5. Aimtec may not have conducted destructive testing or chemical analysis on all internal components and chemical at the time of publishing this document. CAS numbers and other limited information are considered proprietary and may not be available for release. 6. This product is not designed for use in critical life support systems, equipment used in hazardous environments, nuclear control systems or other such applications which necessitate specific safety and regulatory standards other than the ones listed in this datasheet. 7. Warranty is in accordance with Aimtec's standard Terms of Sale available at www.aimtec.com.