

Click to
ORDER
samples

AMSR2-78LPZ



The AMSR2-78LPZ series are SIP3 DC/DC high efficiency switching regulators and ideal substitutes for LM78xx series three-terminal linear regulators. The switching regulators feature high efficiency, low loss, short circuit protection, and there is no need for a heat sink.

It also features excellent reliability and performance while offering a wide input voltage range of 4.5-36VDC as well as an output voltage of 1.8~15V. This compact SIP3 design will surely benefit your new system design.

This new series offers great operating temperatures, from -40 to 85°C with full power up to 71°C. Additionally, 2,000,000 hours MTBF comes standard.

The AMSR2-78LPZ is suitable for instrumentation, industrial control and electric power.

Features

- Pin-out compatible with LM78XX Linear
- Non isolated, heatsinks not required
- Efficiency up to 96%
- Operating Temp: -40 °C to +85 °C
- Short circuit protection: Continuous, Auto recovery
- No-load input current as low as 0.2mA
- Regulated output



Summary

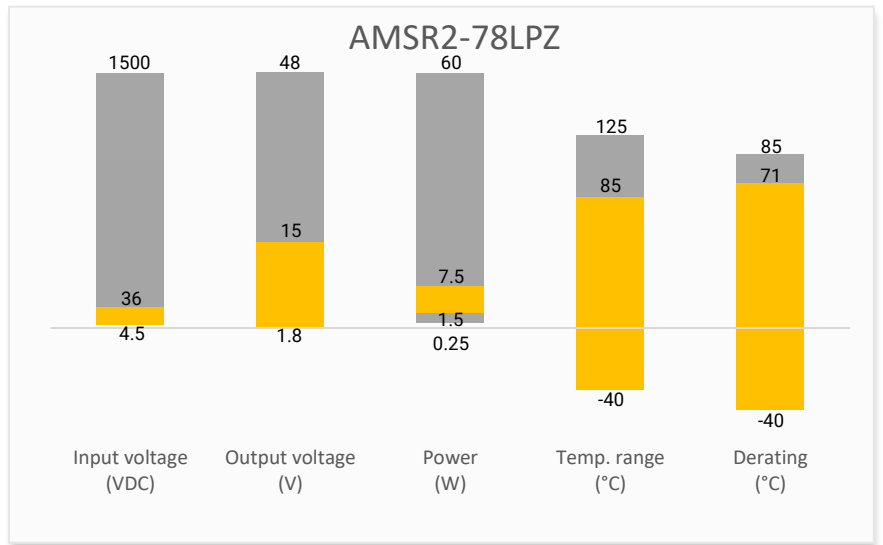

Training



Product Training Video
(click to open)

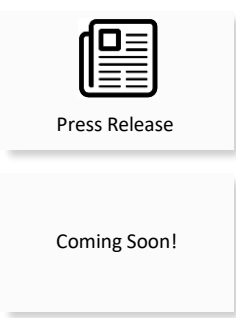

Application Notes

Applications



IoT

Industrial

Telecom

Portable Equipment

Models & Specifications



Model	Input Voltage (VDC)	Output Voltage (VDC)	Output Current max (mA)	Maximum capacitive Load (μF)	Efficiency Vin Min (%)	Efficiency Vin Max (%)
Straight Pins						
AMSR2-781.8LPZ	4.5-28	1.8	2000	2000	83	79
AMSR2-782.5LPZ	4.5-28	2.5	2000	2000	89	83
AMSR2-783.3LPZ	6-36	3.3	2000	1800	89	85
AMSR2-7805LPZ	8-36	5	2000	1000	92	89
AMSR2-786.5LPZ	10-36	6.5	2000	1000	92	89
AMSR2-7809LPZ	13-36	9	2000	680	95	92
AMSR2-7812LPZ	16-36	12	2000	470	96	94
AMSR2-7815LPZ	18-36	15	2000	470	96	94
Right Angled Pins						
AMSR2-781.8LLPZ	4.5-28	1.8	2000	2000	83	79
AMSR2-782.5LLPZ	4.5-28	2.5	2000	2000	89	83
AMSR2-783.3LLPZ	6-36	3.3	2000	1800	89	85
AMSR2-7805LLPZ	8-36	5	2000	1000	92	89
AMSR2-786.5LLPZ	10-36	6.5	2000	1000	92	89
AMSR2-7809LLPZ	13-36	9	2000	680	95	92
AMSR2-7812LLPZ	16-36	12	2000	470	96	94
AMSR2-7815LLPZ	18-36	15	2000	470	96	94

NOTE: The LLPZ suffix indicate right angled pins and the LPZ suffix indicates straight pins.

Input Specification

Parameters	Conditions	Typical	Maximum	Units
Voltage range	See models table			VDC
No load input current		0.2	1	mA
Filter	Capacitor			

Output Specification

Parameters	Conditions	Typical	Maximum	Units
Voltage accuracy	100% load, 1.8/2.5/3.3Vout model	±2	±4	%
	100% load, Others	±2	±3	%
Line regulation	100% load	±0.4	±0.8	%
Load regulation	10-100% load	±0.5	±1.5	%
Ripple & Noise*		30	75	mV pk-pk
Transient response time	25% load step change	200	1000	μS
Dynamic load stability	25% load step change, 1.8/2.5/3.3Vout models	±80	±150	mV
	25% load step change, others	±50	±150	mV

* Ripple and Noise are measured at 20MHz bandwidth. Please refer to the application note for specific detail.

General Specifications

Parameters	Conditions	Typical	Maximum	Units
Switching frequency	Full load, nominal input	400		KHz
Short circuit protection	Continuous, auto recovery			
Operating temperature	With derating at 71°C	-40 to +85		°C

Storage temperature		-55 to +125		°C
Temperature coefficient		±0.03		%/°C
Pin soldering temperature	Soldering spot is 1.5mm away from case, 10 sec max		260	°C
Cooling	Free air convection			
Humidity	Non-condensing		95	% RH
Case material	black plastic (UL94V-0 rated)			
Weight		4		g
Dimensions (L x W x H)	0.45 x 0.35 x 0.69 inches (11.50 x 9.00 x 17.50 mm)			
MTBF	2 000 000 hrs (MIL-HDBK -217F, t=+25°C) / Full Load			
NOTE: All specifications in this datasheet are measured at an ambient temperature of 25°C, humidity<75%, nominal input voltage and at rated output load unless otherwise specified.				

Safety Specifications		
Parameters		
Standards	Designed to meet UL/EN/IEC 62368-1	
	EMC - Conducted and radiated emission	CISPR32 / EN55032, class B with the recommended EMC circuit
	Electrostatic Discharge Immunity	IEC/EN 61000-4-2 Contact ±4KV, Criteria B
	RF, Electromagnetic Field Immunity	IEC/EN 61000-4-3 10V/m, Criteria A
	Electrical Fast Transient/Burst Immunity	IEC/EN 61000-4-4 ±1KV, Criteria B
	RF, Conducted Disturbance Immunity	IEC/EN 61000-4-6 3Vr.m.s, Criteria A

Derating

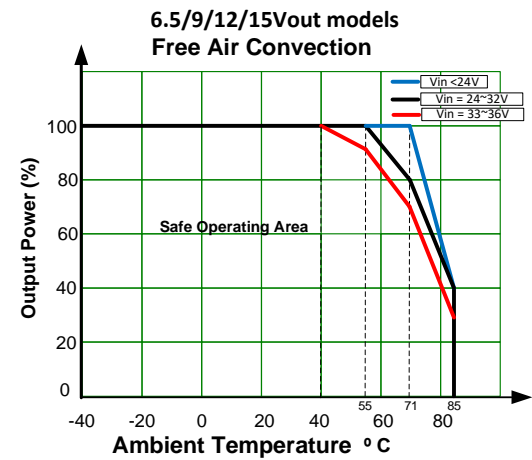
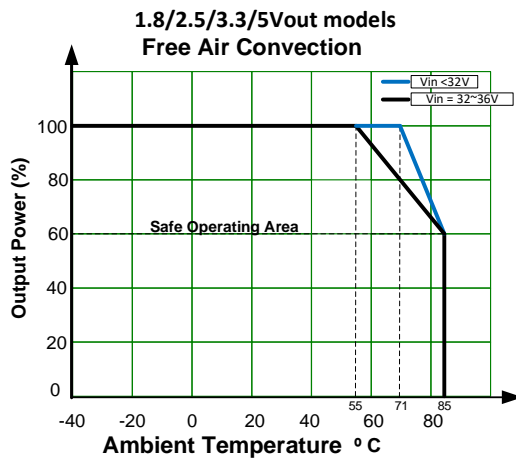

Typical application circuit

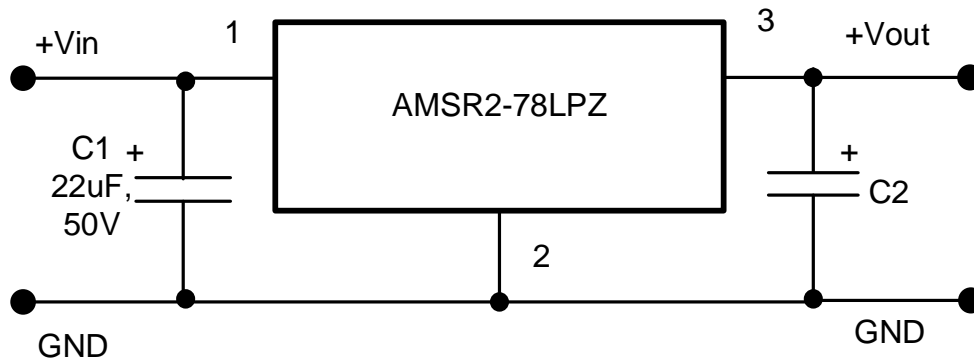

Vout	C2
1.8V	22μF/10V
2.5V	22μF/10V
3.3V	22μF/10V
5V	22μF/10V
6.5V	22μF/10V
9V	22μF/16V
12V	22μF/25V
15V	22μF/25V

EMI Recommended circuit

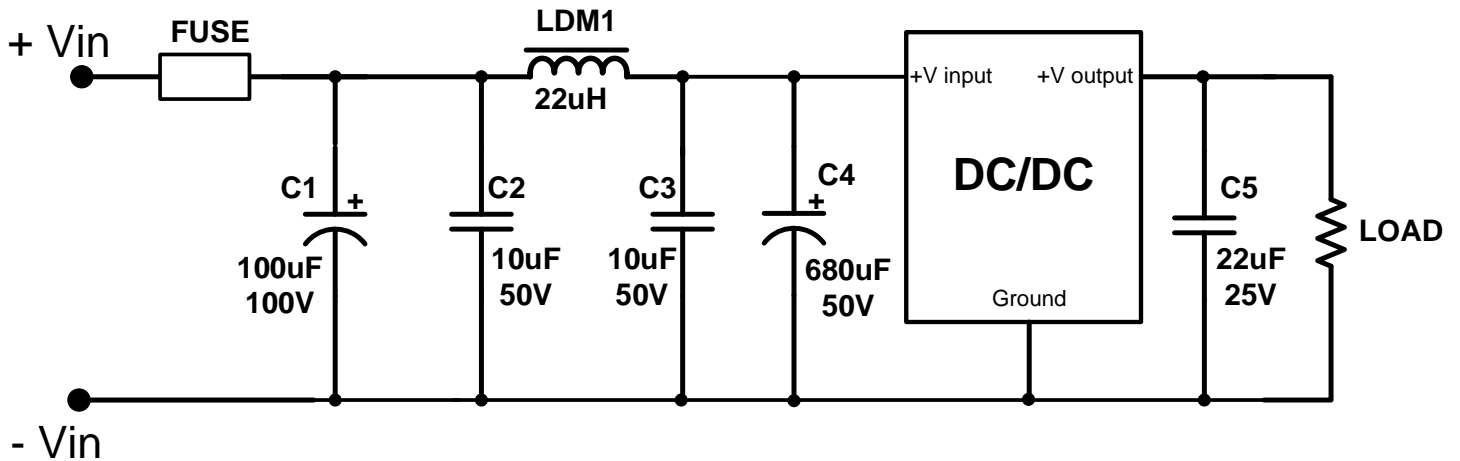

Dimensions

Straight pin models

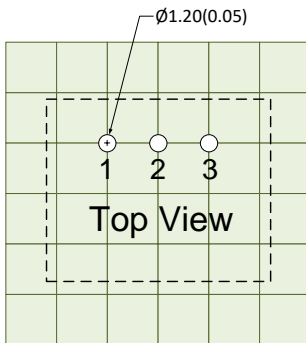
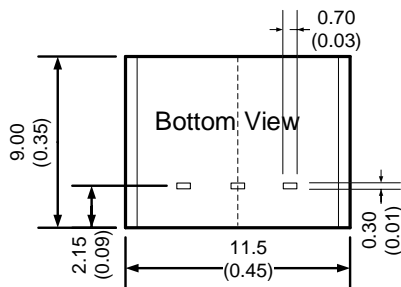
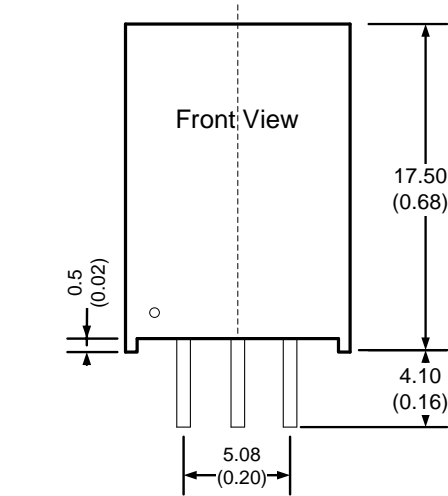

Grid: 2.54 x 2.54mm
 Unit:mm[inch]
 General tolerances: $\pm 0.5\text{mm} [\pm 0.020\text{inch}]$

Right angled pin models

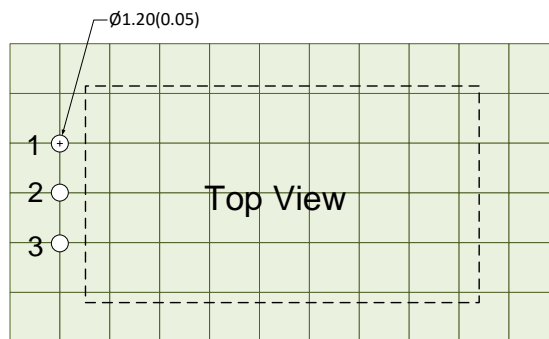
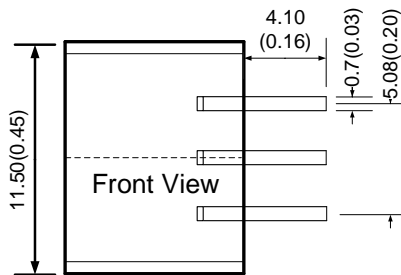
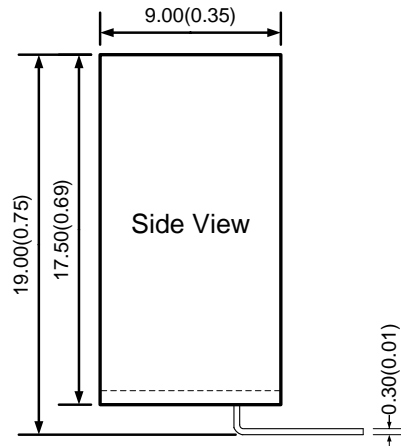

Grid: 2.54 x 2.54mm
 Unit:mm[inch]
 General tolerances: $\pm 0.50\text{mm} [\pm 0.020\text{inch}]$

Pin Out Specifications

Pin	Positive
1	+V Input
2	Ground
3	+V Output

NOTE: 1. Datasheets are updated as needed and as such, specifications are subject to change without notice. Once printed or downloaded, datasheets are no longer controlled by Aimtec; refer to www.aimtec.com for the most current product specifications. **2.** Product labels shown, including safety agency certifications on labels, may vary based on the date manufactured. **3.** Mechanical drawings and specifications are for reference only. **4.** All specifications are measured at an ambient temperature of 25°C, humidity<75%, nominal input voltage and at rated output load unless otherwise specified. **5.** Aimtec may not have conducted destructive testing or chemical analysis on all internal components and chemicals at the time of publishing this document. CAS numbers and other limited information are considered proprietary and may not be available for release. **6.** This product is not designed for use in critical life support systems, equipment used in hazardous environments, nuclear control systems or other such applications which necessitate specific safety and regulatory standards other the ones listed in this datasheet. **7.** Warranty is in accordance with Aimtec's standard Terms of Sale available at www.aimtec.com.