

Click to
ORDER
samples

AMESP750U-NZ



Enclosed

The AMESP750U-NZ series is an efficient, enclosed, fan less, ultra-narrow, and semi-potted 750W AC/DC power supply module. It offers a wide commercial input voltage range of 90-264VAC, output voltage ranges from 12-48V, low power consumption, high efficiency, high reliability, and safer isolation.

This new series offers great operating temperatures, from -30°C to +75°C with full power up to 45°C and features an isolation of 3750VAC with improved reliability and system safety. Furthermore, a high MTBF of 100,900h, output short circuit protection (OSCP), output over-current protection (OCP), output over-voltage protection (OVP), and over temperature protection (OTP) come standard with the series.

The AMESP750U-NZ is suitable for street lighting controls, grid power, instrumentation, industrial controls, communication, and civil applications.

Features

- Universal Input: 90 - 264VAC/127 - 370VDC
- Operating Temp: -30°C to +75°C
- High isolation voltage: 3750VAC
- Active PFC
- Output short circuit, over-current, over-voltage, over-temperature protection
- Efficiency up to 95%

Summary

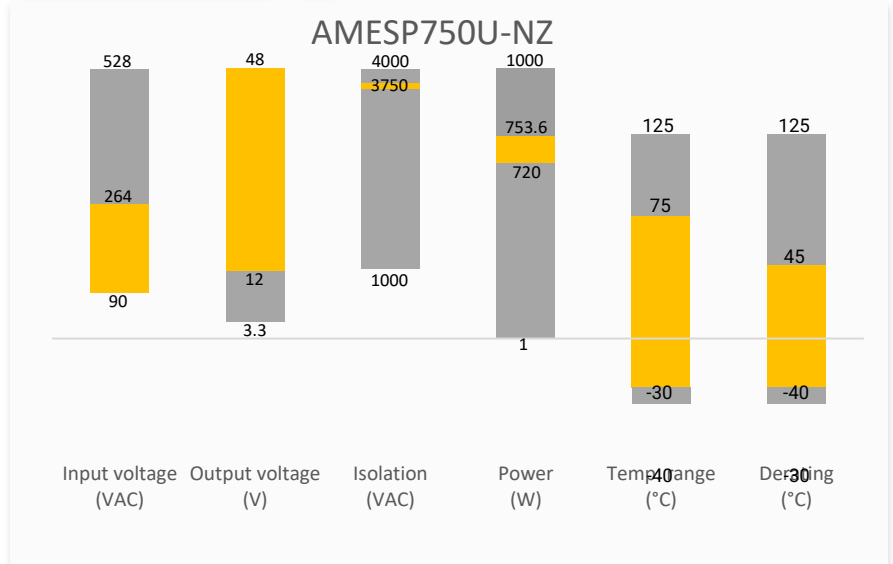

Training



Product Training Video



Press Release

Coming Soon!

Application Notes

Applications



Power Grid



Industrial



Telecom

Models & Specifications



Single Output

Model	Input Voltage (VAC/Hz)	Input Voltage (VDC)	Max Output Wattage (W)	Output Voltage (V)	Output Voltage Adjustable Range (V)	Output Current max (A)	Maximum capacitive load (μ F)	Average Efficiency (%)
AMESP750U-12SNZ-P	90-264/47-63	127-370	720	12	12-14.4	60	12000	93.5
AMESP750U-24SNZ-P	90-264/47-63	127-370	751.2	24	24-28.8	31.3	10000	95
AMESP750U-36SNZ-P	90-264/47-63	127-370	752.4	36	36-43.2	20.9	8000	95
AMESP750U-48SNZ-P	90-264/47-63	127-370	753.6	48	48-57.6	15.7	6000	95

Note: The "-P" suffix indicates a terminal protective cover (ex. AMESP750U-12SNZ-P). For optional conformal coating, add "Q" after the "-P" (ex. AMESP750U-12SNZ-PQ is conformal coated version with terminal protective cover).

Input Specifications

Parameters	Conditions	Typical	Minimum	Maximum	Units
Input current	115VAC			7.5	A
	230VAC			3.8	A
Inrush current	Cold Start, 115VAC	20			A
	Cold Start, 230VAC	40			A
Leakage	240VAC			<0.75	mA
Power Factor	Full Load, 115VAC	0.98			
	Full Load, 230VAC	0.95			

Output Specifications

Parameters	Conditions	Typical	Maximum	Units
Voltage accuracy	Full Load Range	± 1.0		%
Line regulation	Rated Load	± 0.5		%
Load Regulation	0%-100% Load	± 0.5		%
Ripple & Noise*	12V output		150	mV p-p
	24V output		200	mV p-p
	36V, 48V output		250	mV p-p
Hold up time	Full Load, 115VAC/230VAC	12		ms

* Ripple and Noise are measured at 20MHz bandwidth with a 47 μ F electrolytic capacitor and a 0.1 μ F ceramic capacitor. Please refer to the application note for specific details.

Isolation Specifications

Parameters	Conditions	Typical	Rated	Units
Tested I/O voltage	60 sec		3750	VAC
Tested Input to GND voltage	60 sec		2000	VAC
Tested Output to GND voltage	60 sec		1250	VAC
Resistance (I/O, I/O to GND) *	500VDC		100	M Ω

* Tested under 25 \pm 5 $^{\circ}$ C ambient temperature with relative humidity <95% and no condensation.

General Specifications

Parameters	Conditions	Typical	Minimum	Maximum	Units
Safety class	Class I According to EN62368-1				
Over current protection	Hiccup, Auto recovery	≥ 105		150	% of Iout
Over voltage protection	Shut-down, Manual recovery, 12V output		14.5	16	VDC
	Shut-down, Manual recovery, 24V output		29	33	VDC
	Shut-down, Manual recovery, 36V output		43.5	49	VDC

	Shut-down, Manual recovery, 48V output		59	66	VDC
Over temperature protection	Shut-down, Auto recovery				
Short circuit protection	Hiccup, Continuous, Auto recovery				
Operating temperature	See derating graph		-30	+75	°C
Storage temperature			-40	+85	°C
Power Derating	45°C to 70°C, 12V output		2		%/°C
	50°C to 70°C, others		2.5		%/°C
	90VAC ~ 180VAC		0.33		%/VAC
Temperature coefficient	0 ~ 50 °C	±0.03			% / °C
Cooling	Free air convection				
Operating humidity	Non-condensing		20	90	% RH
Storage humidity	Non-condensing		10	95	% RH
Case material	Metal				
Weight		1500			g
Dimensions (L x W x H)	9.33 x 3.94 x 1.61 inches (237.00 x 100.00 x 41.00 mm)				
Vibration	10 ~ 500H, 5G 10min / 1cycle, 60min. Each along X, Y, Z axes				
MTBF	> 100 900 hrs MIL-HDBK-217(25°C)				
NOTE: All specifications in this datasheet are measured at an ambient temperature of 25°C, humidity<75%, nominal input voltage and at rated output load unless otherwise specified.					

Safety Specifications		
Parameters		
Standards	Information technology Equipment	Designed to meet BS EN/EN62368-1
	EMC - Conducted and radiated emission	CISPR32 / EN55032, class B
	Harmonic current	IEC 61000-3-2
	Voltage flicker	IEC 61000-3-3
	Electrostatic Discharge Immunity	IEC/EN61000-4-2
	RF, Electromagnetic Field Immunity	IEC/EN61000-4-3
	Electrical Fast Transient/Burst Immunity	IEC/EN61000-4-4
	Surge Immunity	IEC/EN61000-4-5
	RF, Conducted Disturbance Immunity	IEC/EN61000-4-6
	Power Frequency Magnetic Field	IEC/EN61000-4-8
	Voltage dips, Short Interruptions Immunity	IEC/EN61000-4-11

Derating

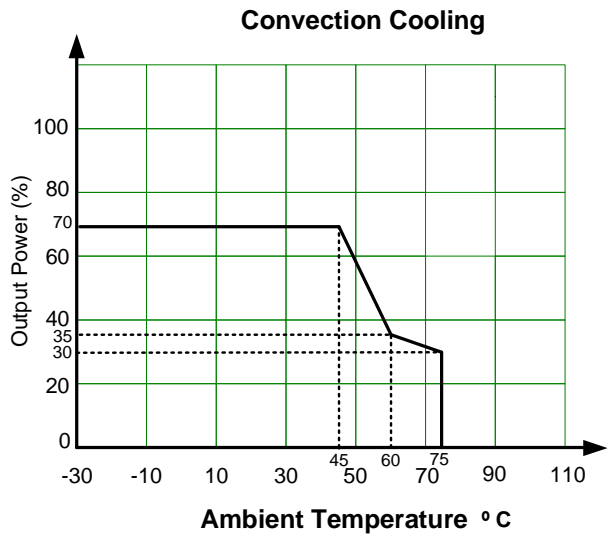
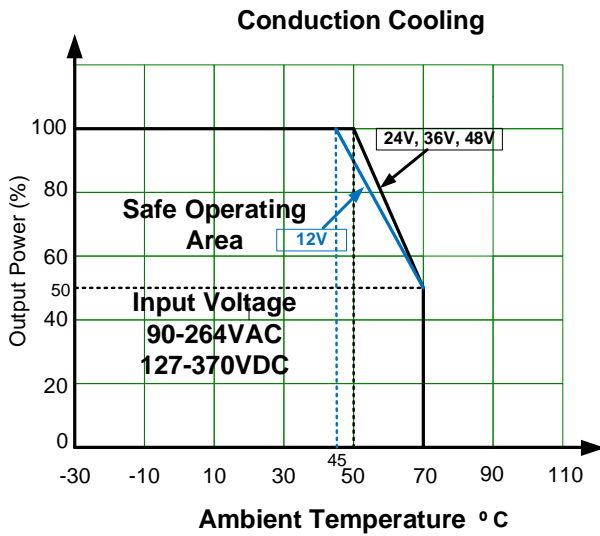

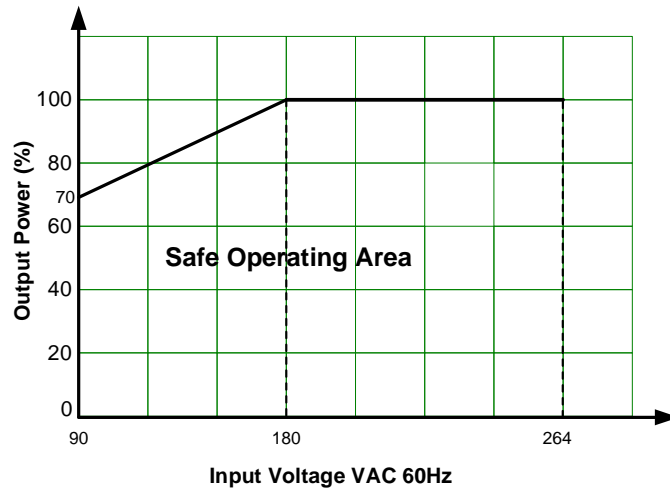

Dimensions

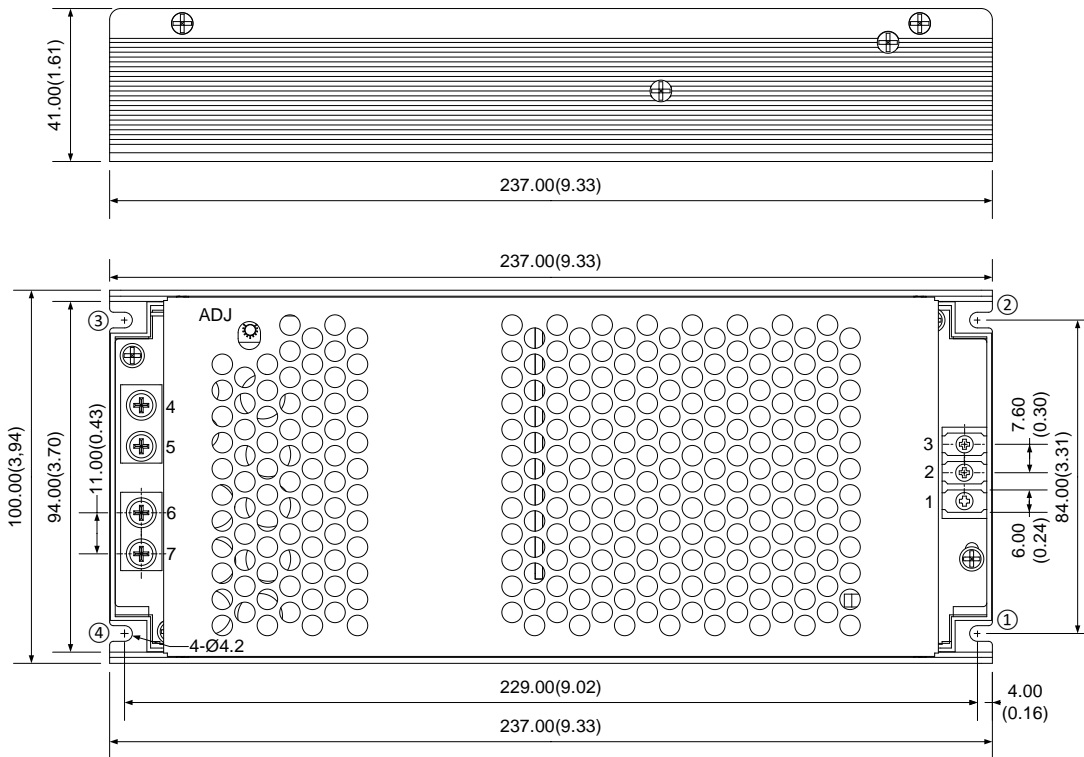

Pin Output Specifications	
Pin	Single
1	PE GND
2	AC Input (N)
3	AC Input (L)
4	-V Output
5	-V Output
6	+V Output
7	+V Output

Note:

Unit: mm(inch)

General tolerance: $\pm 1.0(0.04)$

Connector screw: M3 position 1-3, M4 position 4-7

Note:

1. Operate with additional aluminum plate to meet the "Derating Curve" and the "Static Characteristics", the series model must be installed onto an aluminum plate (or the cabinet of the same size) on the bottom. The size of the suggested aluminum plate is 450mm x 450mm. And for optimizing thermal performance, the aluminum plate must have an even and smooth surface (or coated with thermal grease), and the series model must be firmly mounted at the center of the aluminum plate.
2. It is suggested to install the product with M3 combination screws, and the product must be firmly installed at the center of the aluminum plate.

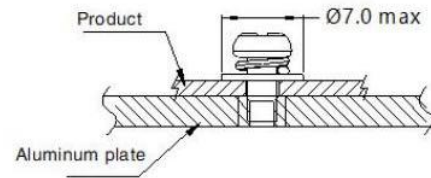
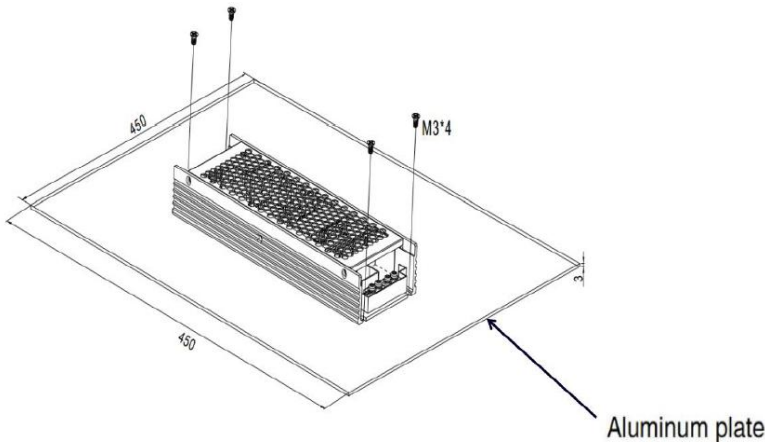

Position	Screw Spec.	Torque(max)
① - ④	M3	0.4N · m

NOTE: **1.** Datasheets are updated as needed and as such, specifications are subject to change without notice. Once printed or downloaded, datasheets are no longer controlled by Aimtec; refer to www.aimtec.com for the most current product specifications. **2.** Product labels shown, including safety agency certifications on labels, may vary based on the date manufactured. **3.** Mechanical drawings and specifications are for reference only. **4.** All specifications are measured at an ambient temperature of 25°C, humidity<75%, nominal input voltage and at rated output load unless otherwise specified. **5.** Aimtec may not have conducted destructive testing or chemical analysis on all internal components and chemicals at the time of publishing this document. CAS numbers and other limited information are considered proprietary and may not be available for release. **6.** This product is not designed for use in critical life support systems, equipment used in hazardous environments, nuclear control systems or other such applications which necessitate specific safety and regulatory standards other the ones listed in this datasheet. **7.** Warranty is in accordance with Aimtec's standard Terms of Sale available at www.aimtec.com.