

Click to
ORDER
samples

AMESP500-277NZ



Enclosed

The AMESP500-277NZ offers much greater cost effectiveness due to material normalization and production automation also leading to improved reliability and performance. Offering a commercial input voltage range of 90-305VAC and an output voltage range from 5-48V, this series will offer many benefits to your new system design.

This new series offers great operating temperatures, from -30°C to 50°C with full power and also features an isolation of 3000VAC for improved reliability and system safety. Furthermore, a high MTBF of 180,000h, output short circuit protection (OSCP), output over-current protection (OCP), output over-voltage protection (OVP) and over-temperature protection (OTP) come standard with the series.

The AMESP500-277NZ is suitable for street lighting controls, grid power, instrumentation, industrial controls, communication, and civil applications.

Features



- Universal Input: 90 - 305VAC/127 - 430VDC
- Operating Temp: -30 °C to +70 °C
- PFC>0.95
- High isolation voltage: Up to 3000VAC
- Low ripple & noise, 150mV(p-p) typ.
- Output short circuit, over-current, over-voltage and over temperature protection
- Regulated Output
- Optional conformal coating
- Active power factor correction

Summary

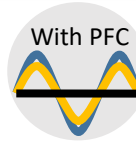
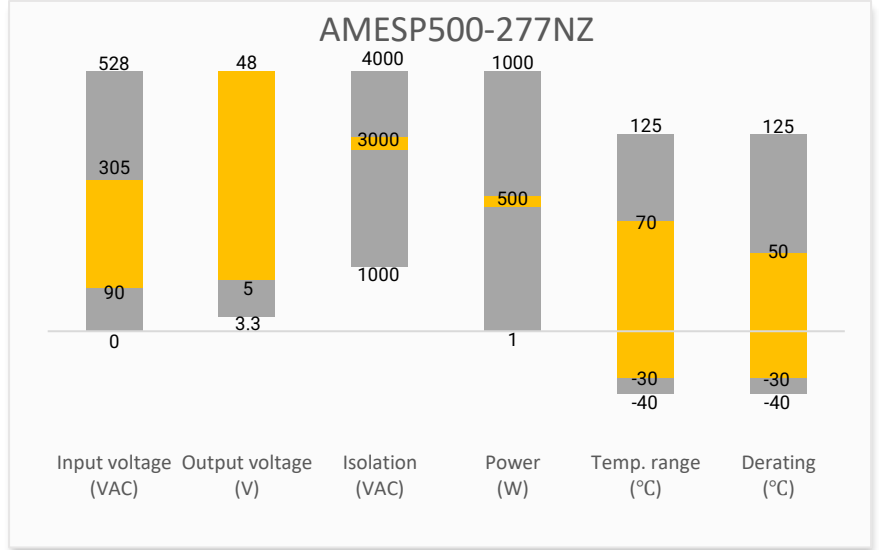

Training



Product Training Video
(click to open)

 Press Release

 Coming Soon!

Application Notes

Applications



Power Grid



Industrial



Telecom



Instrumentation

Models & Specifications

Single Output

Model	Input Voltage (VAC/Hz)	Input Voltage (VDC)	Max Output Wattage (W)	Output Voltage (V)	Output Voltage Adjustable Range (V)	Output Current max (A)	Maximum capacitive load (μF)	Average Efficiency (%)
AMESP500-5S277NZ-P	90-305/47-63	127-430	450	5	4.5-5.5	90	45000	84
AMESP500-12S277NZ-P	90-305/47-63	127-430	500.4	12	10.0-13.2	41.7	40000	88
AMESP500-15S277NZ-P	90-305/47-63	127-430	501	15	13.5-18.0	33.4	10000	88
AMESP500-24S277NZ-P	90-305/47-63	127-430	504	24	20.0-26.4	21	6000	89
AMESP500-36S277NZ-P	90-305/47-63	127-430	500.4	36	34.2-39.6	13.9	3000	90
AMESP500-48S277NZ-P	90-305/47-63	127-430	504	48	41.0-56.0	10.5	1800	90.5

Note: The “-P” suffix indicates a terminal protective cover (ex. AMESP500-5S277NZ-P). For optional conformal coating, add “Q” after the “-P” (ex. AMESP500-5S277NZ-PQ is conformal coated version with terminal protective cover).

Input Specifications

Parameters	Conditions	Typical	Maximum	Units
Input current	115VAC	5.3		A
	230VAC	2.65		A
Inrush current	115VAC, cold start	20		A
	230VAC, cold start	40		A
Power factor	115VAC, Full load	0.98		
	230VAC, Full load	0.95		
Leakage current	240VAC		2	mA
Remote control	Power ON, open or 0 ~ 0.8VDC between RC+(Pin 4) & RC-(Pin3) on CN100			
	Power OFF, 4 ~ 10VDC between RC+(Pin 4) & RC-(Pin3) on CN100			

Output Specifications

Parameters	Conditions	Typical	Maximum	Units
Voltage accuracy	Full load, 5V output	±2		%
	Full load, others	±1		%
Line regulation	Full load, 5V output	±0.5		%
	Full load, 12V, 15V output	±0.3		%
	Full load, others	±0.2		%
Load regulation	0-100% load, 5V output	±1		%
	0-100% load, others	±0.5		%
Ripple & Noise*			150	mV p-p
Hold up time	115VAC	14		ms
	230VAC	18		ms

* Ripple and Noise are measured at 20MHz bandwidth with a 47μF electrolytic capacitor and a 0.1μF ceramic capacitor. Please refer to the application note for specific details.

Isolation Specifications

Parameters	Conditions	Typical	Rated	Units
Tested I/O voltage	60 sec		3000	VAC
Tested Input to GND voltage	60 sec		2000	VAC
Tested Output to GND voltage	60 sec		500	VAC
Resistance (I/O, I/O to GND) *	500VDC		100	MΩ

* Tested under 25±5°C ambient temperature with relative humidity <95% and no condensation.

General Specifications				
Parameters	Conditions	Typical	Maximum	Units
Safety class	Class I			
Over voltage category	OVC III			
Over Current protection	Constant current limiting, Auto recovery	≥ 105	130	% of I _{out}
Over voltage protection	Shut-down, Manual recovery, 5V output		6.75	VDC
	Shut-down, Manual recovery, 12V output		16.2	VDC
	Shut-down, Manual recovery, 15V output		21.8	VDC
	Shut-down, Manual recovery, 24V output		32.4	VDC
	Shut-down, Manual recovery, 36V output		48.6	VDC
	Shut-down, Manual recovery, 48V output		64.6	VDC
Over temperature protection	Shut-down, Auto recovery			
Short circuit protection	Hiccup, Continuous, Auto recovery			
Remote sense	Compensate voltage drop on the load wiring up to 0.3V Connect Load side +V _{out} with +S(Pin 2) on CN100 and load side -V _{out} with -S(Pin 1) on CN100			
Operating temperature	See derating graph	-30 to +70		°C
Storage temperature		-40 to +85		°C
Power derating	50 °C to 70 °C	2.5		% / °C
	90VAC ~ 105VAC@60Hz	1.33		% / VAC
Temperature coefficient	0 ~ 50 °C	±0.03		% / °C
Cooling	Forced air cooling			
Fan control (Typ.)	R _{th} ≥ 50°C ± 10°C Fan on; R _{th} ≤ 40°C Fan off (Fan always on for 5V output model)			
Humidity	Non-condensing, Storage	≥ 10	95	% RH
	Non-condensing, Operating	≥ 20	90	% RH
Case material	Metal			
Weight		1300		g
Dimensions (L x W x H)	9.06 x 5.00 x 1.59inch (230.0 x 127.0 x 40.5mm)			
Vibration	10 ~ 500H, 2G 10min / 1cycle, 60min. Each along X, Y, Z axes			
MTBF	> 180 000 hrs MIL-HDBK-217(25°C)			
NOTE: All specifications in this datasheet are measured at an ambient temperature of 25°C, humidity < 75%, nominal input voltage and at rated output load unless otherwise specified.				

Safety Specifications		
Parameters		
Standards	Over voltage category	Design to meet III; According to EN62368-1
	Information technology Equipment	Design to meet UL62368-1, TUV BS EN/EN62368-1
	EMC - Conducted and radiated emission	CISPR32 / EN55032, class B
	Harmonic current	IEC 61000-3-2, class A
	Voltage flicker	IEC 61000-3-3
	Electrostatic Discharge Immunity	IEC 61000-4-2, Criteria A
	RF, Electromagnetic Field Immunity	IEC 61000-4-3, Criteria A
	Electrical Fast Transient/Burst Immunity	IEC 61000-4-4, Criteria A
	Surge Immunity	IEC 61000-4-5, Criteria A
	RF, Conducted Disturbance Immunity	IEC 61000-4-6, Criteria A
	Power-frequency Magnetic Field	IEC 61000-4-8, Criteria A
	Voltage dips, Short Interruptions Immunity	IEC 61000-4-11, Criteria B

Derating



Free Air Convection

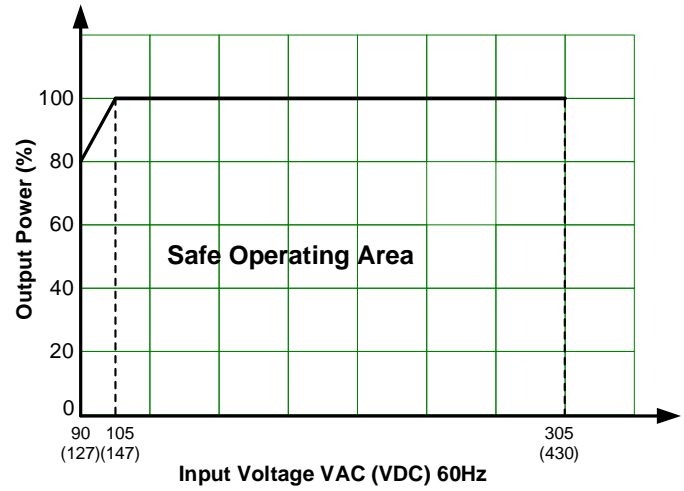
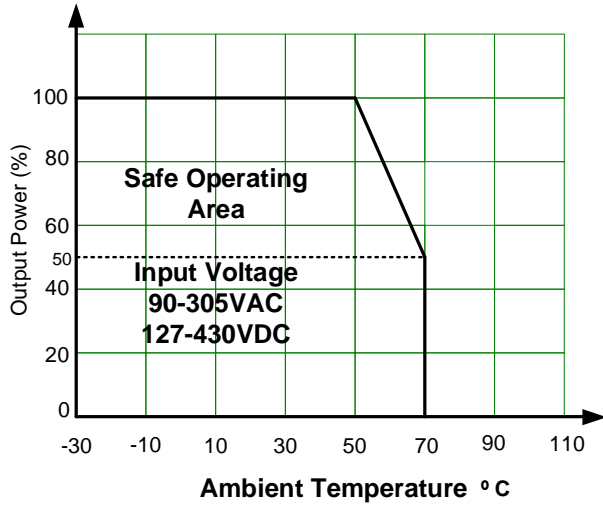

Dimensions

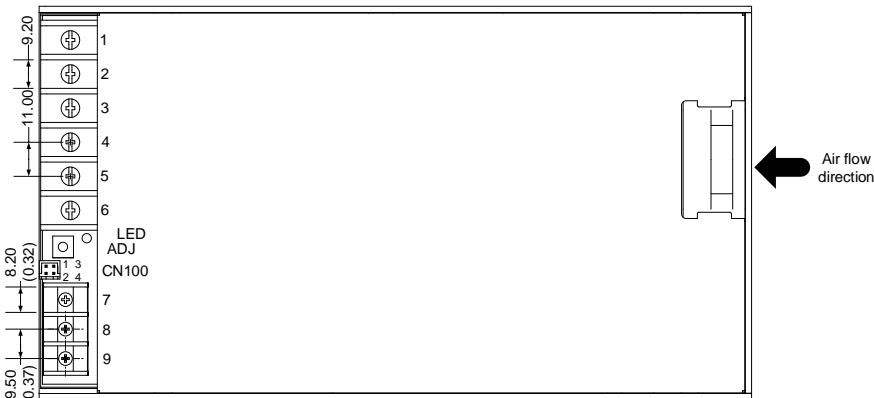
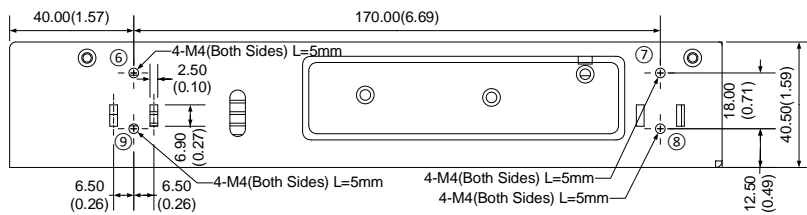
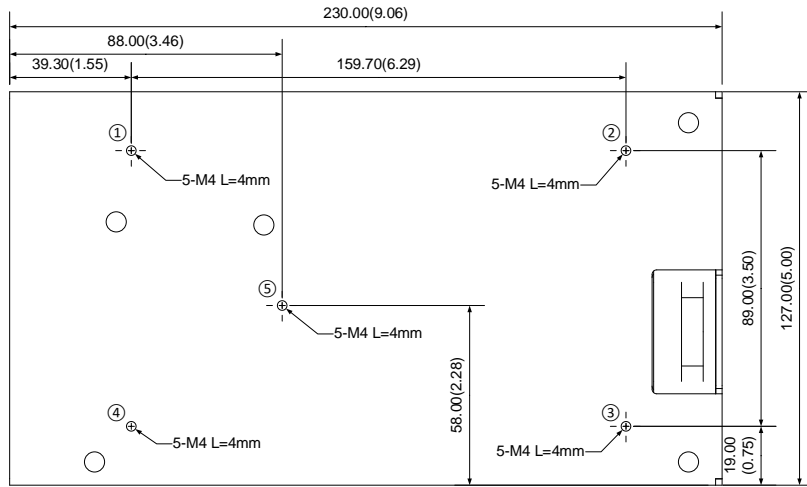

Note:
Unit: mm(inch)
ADJ: Output adjustable resistor
Wire gauge: 22-12AWG
Connector tightening torque: M3.5, 0.8N-m
General tolerance: $\pm 1.0(0.04)$
At least one of the ① - ⑨ location must be connected to PE

Pin Output Specifications	
Pin	Single
1	+V Output
2	+V Output
3	+V Output
4	-V Output
5	-V Output
6	-V Output
7	PE GND
8	AC Input (N)
9	AC Input (L)

CN100 Specifications			
Pin	Description	Mating Housing	Terminal
1	-S	HRS DF11-4DS or equivalent	HRS DF11-**SC or equivalent
2	+S		
3	RC-		
4	RC+		

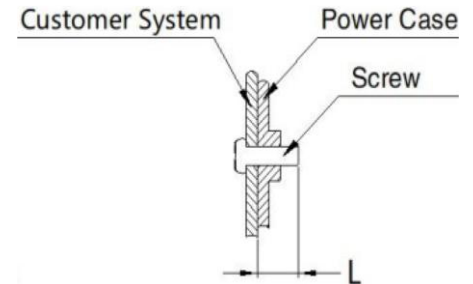

Screw Spec.	L(max)	Torque(max)
M3	4mm	0.4 N-m

NOTE: 1. Datasheets are updated as needed and as such, specifications are subject to change without notice. Once printed or downloaded, datasheets are no longer controlled by Aimtec; refer to www.aimtec.com for the most current product specifications. 2. Product labels shown, including safety agency certifications on labels, may vary based on the date manufactured. 3. Mechanical drawings and specifications are for reference only. 4. All specifications are measured at an ambient temperature of 25°C, humidity<75%, nominal input voltage and at rated output load unless otherwise specified. 5. Aimtec may not have conducted destructive testing or chemical analysis on all internal components and chemicals at the time of publishing this document. CAS numbers and other limited information are considered proprietary and may not be available for release. 6. This product is not designed for use in critical life support systems, equipment used in hazardous environments, nuclear control systems or other such applications which necessitate specific safety and regulatory standards other the ones listed in this datasheet. 7. Warranty is in accordance with Aimtec's standard Terms of Sale available at www.aimtec.com.