

Click to  
**ORDER**  
samples

## AMESP350U-NZ

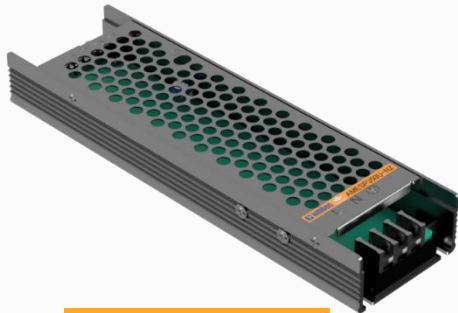

Enclosed

The AMESP350U-NZ series is an efficient, enclosed, fan less, ultra-narrow, and semi-potted 350W AC/DC power supply module. It offers a wide commercial input voltage range of 90-264VAC, output voltage ranges from 4.2-48V, low power consumption, high efficiency, high reliability, and safer isolation.

This new series offers great operating temperatures, from -30°C to +70°C with full power up to 50°C and features an isolation of 3750VAC with improved reliability and system safety. Furthermore, a high MTBF of 253,400h, output short circuit protection (OSCP), output over-current protection (OCP), output over-voltage protection (OVP), and over temperature protection (OTP) come standard with the series.

The AMESP350U-NZ is suitable for street lighting controls, grid power, instrumentation, industrial controls, communication, and civil applications.

## Features

- Universal Input: 90 - 264VAC/127 - 370VDC
- Operating Temp: -30°C to +70°C
- High isolation voltage: 3750VAC
- Active PFC
- Output short circuit, over-current, over-voltage, over-temperature protection
- Efficiency up to 95%

## Summary

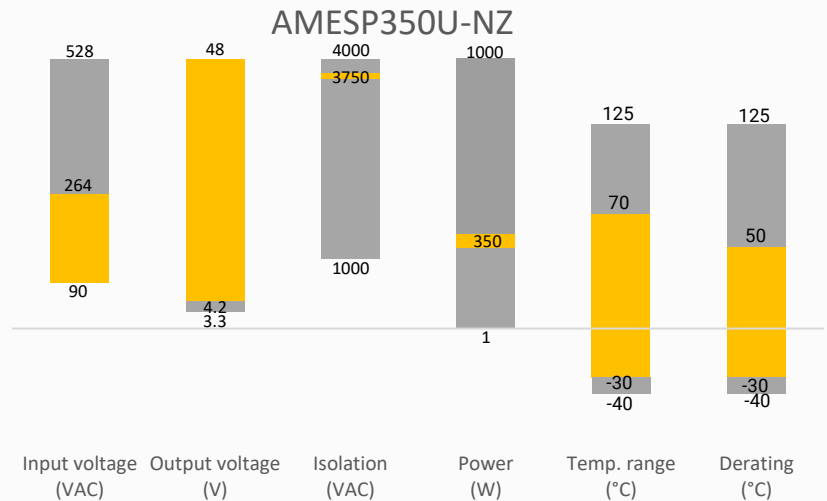

## Training



Product Training Video



Press Release

Coming Soon!

Application Notes

## Applications



Power Grid



Industrial



Telecom

## Models & Specifications



### Single Output

Model	Input Voltage (VAC/Hz)	Input Voltage (VDC)	Max Output Wattage (W)	Output Voltage (V)	Output Voltage Adjustable Range (V)	Output Current max (A)	Maximum capacitive load ( $\mu$ F)	Average Efficiency (%)
AMESP350U-4SNZ-P	90-264/47-63	127-370	252	4.2	3.6-4.4	60	12000	89
AMESP350U-5SNZ-P	90-264/47-63	127-370	300	5	4.5-5.5	60	12000	90
AMESP350U-12SNZ-P	90-264/47-63	127-370	350.4	12	11.4-12.6	29.2	10000	91
AMESP350U-15SNZ-P	90-264/47-63	127-370	351	15	14.3-15.8	23.4	9000	92
AMESP350U-24SNZ-P	90-264/47-63	127-370	350.4	24	22.8-25.2	14.6	8000	94
AMESP350U-36SNZ-P	90-264/47-63	127-370	351	36	34.2-37.8	9.75	6000	94
AMESP350U-48SNZ-P	90-264/47-63	127-370	350.4	48	45.6-50.4	7.3	4000	94

Note: The "-P" suffix indicates a terminal protective cover (ex. AMESP350U-12SNZ-P). For optional conformal coating, add "Q" after the "-P" (ex. AMESP350U-12SNZ-PQ is conformal coated version with terminal protective cover).

### Input Specifications

Parameters	Conditions	Typical	Minimum	Maximum	Units
Input current	115VAC			4	A
	230VAC			2	A
Inrush current	Cold Start, 115VAC	30			A
	Cold Start, 230VAC	60			A
Leakage	240VAC			<0.75	mA
Power Factor	Full Load, 115VAC	0.98			
	Full Load, 230VAC	0.94			

### Output Specifications

Parameters	Conditions	Typical	Maximum	Units
Voltage accuracy	Full Load Range, 4.2V & 5V output	$\pm 2$		%
	Full Load Range, others	$\pm 1$		%
Line regulation	Rated Load, 4.2V output	$\pm 0.5$		%
	Rated Load, others	$\pm 0.3$		%
Load Regulation	0%-100% Load, 4.2V & 5V output	$\pm 1$		%
	0%-100% Load, others	$\pm 0.5$		%
Ripple & Noise*	4.2V output		150	mV p-p
	5V, 12V, 15V output		200	mV p-p
	24V, 36V, 48V output		240	mV p-p
Hold up time	Full Load, 115VAC/230VAC	10		ms

\* Ripple and Noise are measured at 20MHz bandwidth with a 47 $\mu$ F electrolytic capacitor and a 0.1 $\mu$ F ceramic capacitor. Please refer to the application note for specific details.

### Isolation Specifications

Parameters	Conditions	Typical	Rated	Units
Tested I/O voltage	60 sec		3750	VAC
Tested Input to GND voltage	60 sec		2000	VAC
Tested Output to GND voltage	60 sec		1250	VAC
Resistance (I/O, I/O to GND) *	500VDC		100	M $\Omega$

\* Tested under 25 $\pm$ 5 $^{\circ}$ C ambient temperature with relative humidity <95% and no condensation.

General Specifications					
Parameters	Conditions	Typical	Minimum	Maximum	Units
Safety class	Class I				
Over voltage category	OVC III, According to EN62368-1				
Over current protection	Hiccup, Auto recovery	≥ 110		140	% of I <sub>out</sub>
Over voltage protection	Shut-down, Manual recovery, 4.2V output		4.62	5.46	VDC
	Shut-down, Manual recovery, 5V output		5.75	6.75	VDC
	Shut-down, Manual recovery, 12V output		13.2	15.6	VDC
	Shut-down, Manual recovery, 15V output		16.5	19.5	VDC
	Shut-down, Manual recovery, 24V output		26.4	31.2	VDC
	Shut-down, Manual recovery, 36V output		39.6	46.8	VDC
Shut-down, Manual recovery, 48V output		52.8	62.4	VDC	
Over temperature protection	Shut-down, Auto recovery				
Short circuit protection	Hiccup, Continuous, Auto recovery				
Operating temperature	See derating graph		-30	+70	°C
Storage temperature			-40	+85	°C
Power Derating	50°C to 70°C, Conduction		2		%/°C
	45°C to 70°C, Convection, 110VAC		1.2		%/°C
	45°C to 70°C, Convection, 230VAC 4.2V & 5V		1.6		%/°C
	50°C to 70°C, Convection, 230VAC others		3		%/°C
	90VAC ~ 110VAC		1.25		%/VAC
Temperature coefficient	0 ~ 50 °C	±0.03			% / °C
Cooling	Free air convection				
Operating humidity	Non-condensing		20	90	% RH
Storage humidity	Non-condensing		10	95	% RH
Case material	Metal				
Weight		700			g
Dimensions (L x W x H)	8.66 x 2.44 x 1.22 inches (220.00 x 62.00 x 31.00 mm)				
Vibration	10 ~ 500H, 5G 10min / 1cycle, 60min. Each along X, Y, Z axes				
MTBF	> 253 400 hrs MIL-HDBK-217(25°C)				
NOTE: All specifications in this datasheet are measured at an ambient temperature of 25°C, humidity<75%, nominal input voltage and at rated output load unless otherwise specified.					

Safety Specifications		
Parameters		
Standards	Over voltage category	Designed to meet III; According to EN62368-1
	Information technology Equipment	Designed to meet BS EN/EN62368-1, BS EN/EN60335-1, EN/EN61558-1, BS EN/EN61558-2-16
	EMC - Conducted and radiated emission	CISPR32 / EN55032, class B
	Harmonic current	IEC 61000-3-2
	Voltage flicker	IEC 61000-3-3
	Electrostatic Discharge Immunity	IEC/EN61000-4-2
	RF, Electromagnetic Field Immunity	IEC/EN61000-4-3
	Electrical Fast Transient/Burst Immunity	IEC/EN61000-4-4
	Surge Immunity	IEC/EN61000-4-5
	RF, Conducted Disturbance Immunity	IEC/EN61000-4-6
	Power Frequency Magnetic Field	IEC/EN61000-4-8
Voltage dips, Short Interruptions Immunity	IEC/EN61000-4-11	

Derating

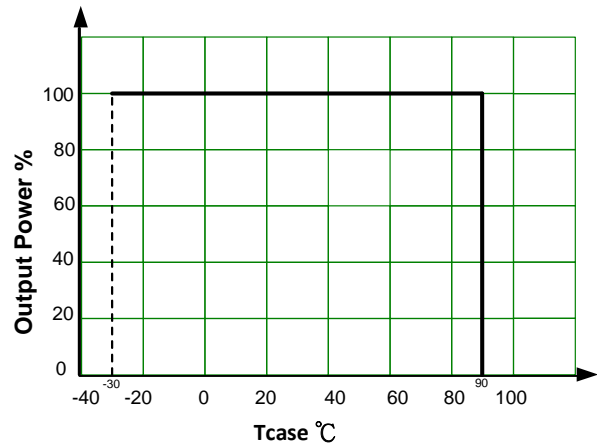
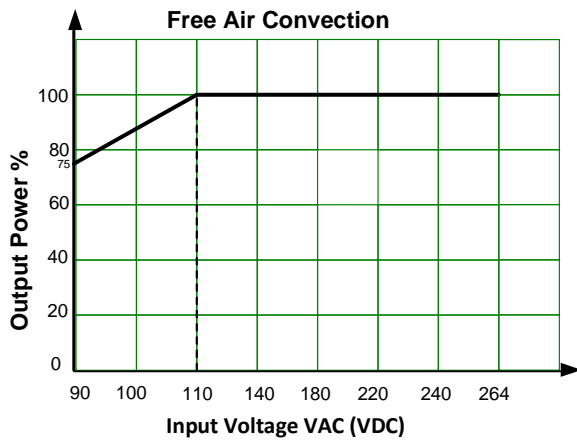
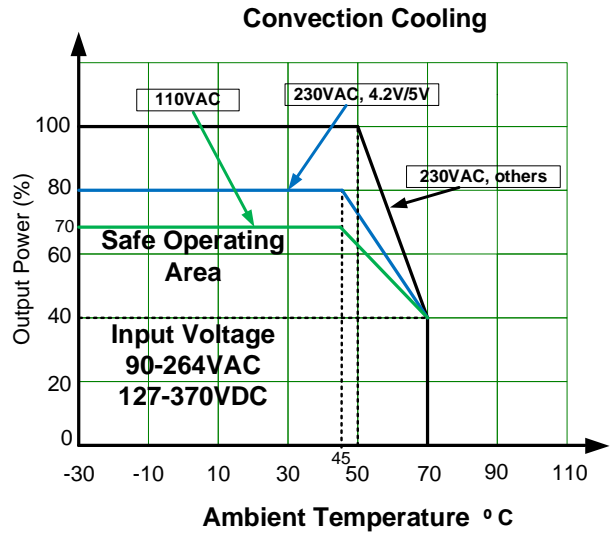
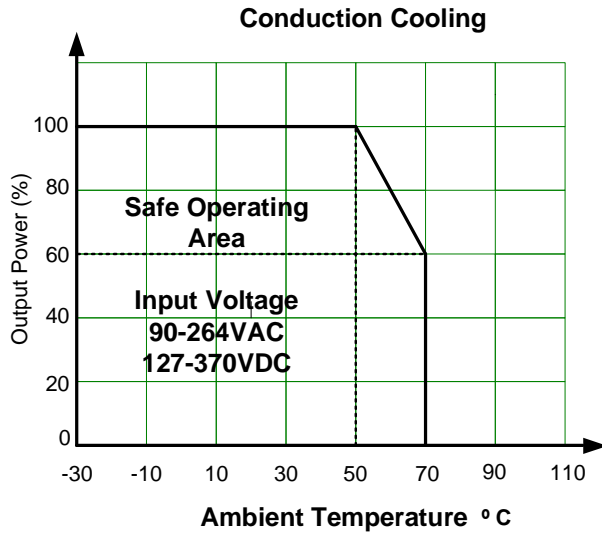

## Dimensions

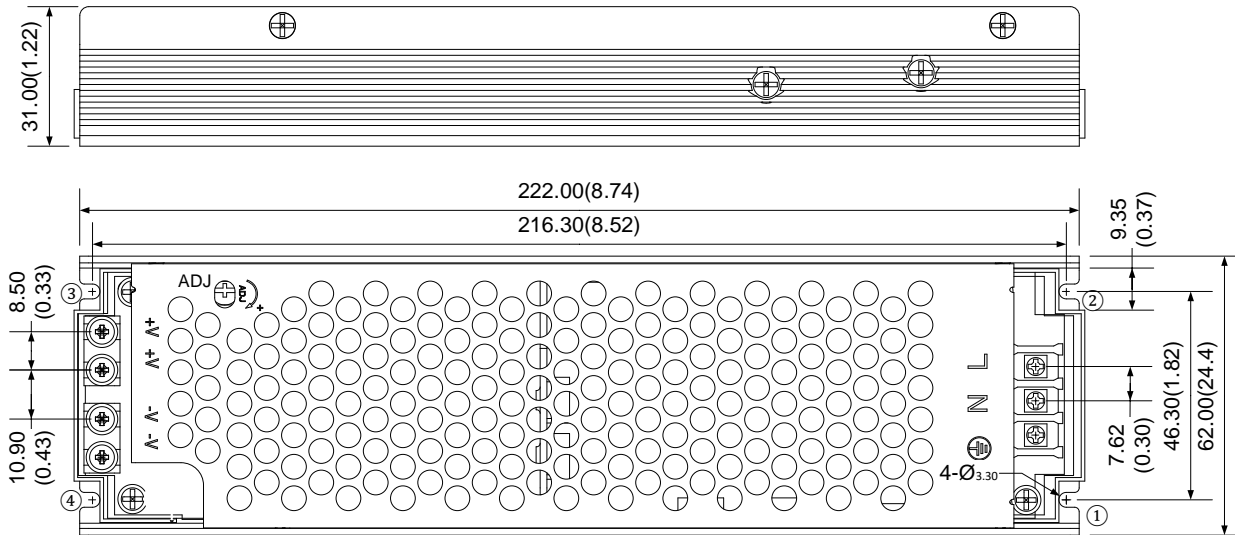

**Note:**

Unit: mm(inch)

General tolerance:  $\pm 1.0(0.04)$

**Note:**

1. Operate with additional aluminum plate to meet the "Derating Curve" and the "Static Characteristics", the series model must be installed onto an aluminum plate (or the cabinet of the same size) on the bottom. The size of the suggested aluminum plate is 450mm x 450mm. And for optimizing thermal performance, the aluminum plate must have an even and smooth surface (or coated with thermal grease), and the series model must be firmly mounted at the center of the aluminum plate.
2. It is suggested to install the product with M3 combination screws, and the product must be firmly installed at the center of the aluminum plate.

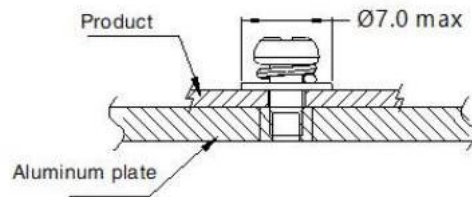
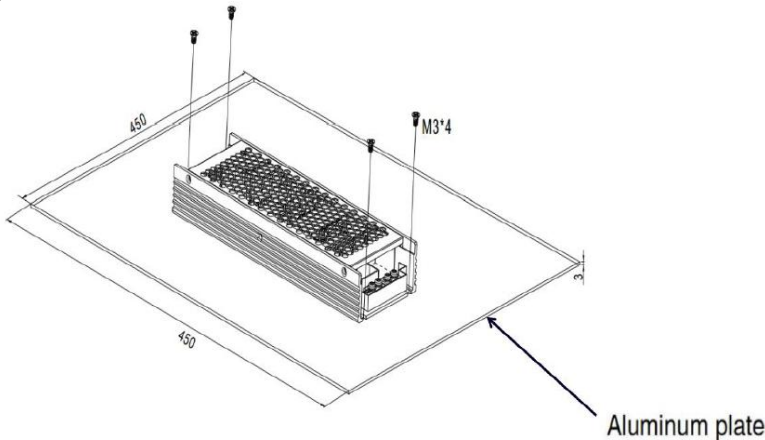

Position	Screw Spec.	Torque(max)
① - ④	M3	0.4N · m

**NOTE:** 1. Datasheets are updated as needed and as such, specifications are subject to change without notice. Once printed or downloaded, datasheets are no longer controlled by Aimtec; refer to [www.aimtec.com](http://www.aimtec.com) for the most current product specifications. 2. Product labels shown, including safety agency certifications on labels, may vary based on the date manufactured. 3. Mechanical drawings and specifications are for reference only. 4. All specifications are measured at an ambient temperature of 25°C, humidity < 75%, nominal input voltage and at rated output load unless otherwise specified. 5. Aimtec may not have conducted destructive testing or chemical analysis on all internal components and chemicals at the time of publishing this document. CAS numbers and other limited information are considered proprietary and may not be available for release. 6. This product is not designed for use in critical life support systems, equipment used in hazardous environments, nuclear control systems or other such applications which necessitate specific safety and regulatory standards other than the ones listed in this datasheet. 7. Warranty is in accordance with Aimtec's standard Terms of Sale available at [www.aimtec.com](http://www.aimtec.com).