

Click to
ORDER
samples

AMESP100-277NZ

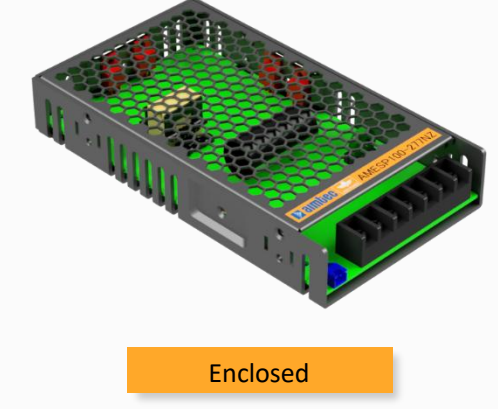

Enclosed

The AMESP100-277NZ is an AC/DC converter that offers much greater cost effectiveness due to material normalization and production automation also leading to improved reliability and performance. Offering a commercial input voltage range of 90-305VAC and an output voltage range from 5-48V, this series will offer many benefits to your new system design.

This new series offers great operating temperatures, from -30°C to 50°C with full power also features isolation of 4000VAC for improved reliability and system safety. Furthermore, a high MTBF of 280,000h, output short circuit protection (OSCP), output over-current protection (OCP), output over-voltage protection (OVP) and over-temperature protection (OTP) come standard with the series.

The AMESP100-277NZ is suitable for street lighting controls, grid power, instrumentation, industrial controls, communication, and civil applications.

Features



- Universal Input: 90 - 305VAC/127 - 430VDC
- Operating Temp: -30 °C to +70 °C
- PFC function
- High isolation voltage: Up to 4000VAC
- Low ripple & noise, 250mV(p-p).
- Output short circuit, over-current, over-voltage and over temperature protection
- Regulated Output

Summary

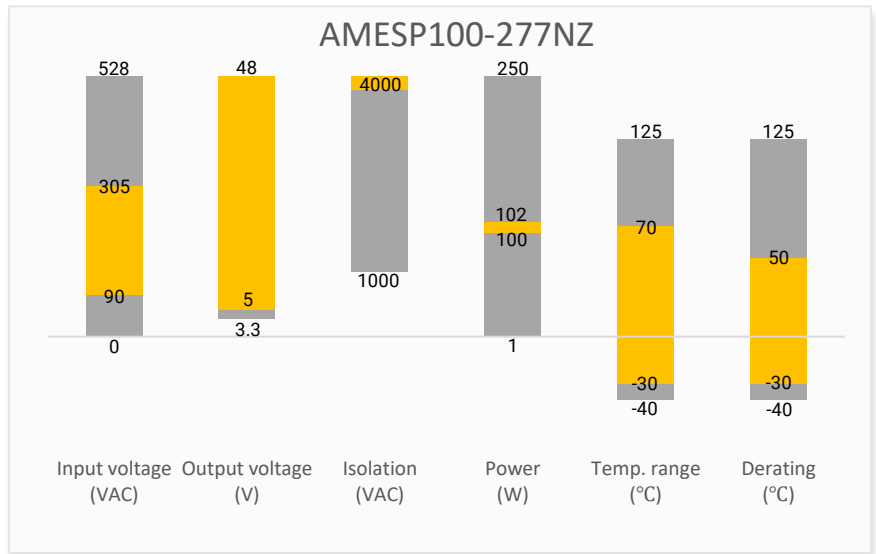

Training

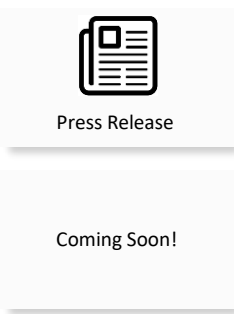
Applications



Product Training Video
(click to open)

Application Notes

Models & Specifications

Single Output

Model	Input Voltage (VAC/Hz)	Input Voltage (VDC)	Max Output Wattage (W)	Output Voltage (V)	Output Voltage Adjustable Range (V)	Output Current max (A)	Efficiency @230VAC (%)
AMESP100-5S277NZ-P	90-305/47-63	127-430	100	5	4.75-5.5	20	86
AMESP100-12S277NZ-P	90-305/47-63	127-430	102	12	11.4-13.2	8.5	86
AMESP100-15S277NZ-P	90-305/47-63	127-430	100.5	15	14.3-16.5	6.7	87
AMESP100-24S277NZ-P	90-305/47-63	127-430	100.8	24	22.8-26.4	4.2	87
AMESP100-48S277NZ-P	90-305/47-63	127-430	100.8	48	45.6-52.8	2.1	88

Note: The "-P" suffix indicates a terminal protective cover and conformal coating (ex. AMESP100-5S277NZ-P).

Input Specifications

Parameters	Conditions	Typical	Maximum	Units
Input current	115VAC	1.1		A
	230VAC	0.55		A
Inrush current	230VAC	30		A
Power factor	115VAC, Full load	0.98		
	230VAC, Full load	0.93		
Leakage current	240VAC		2	mA

Output Specifications

Parameters	Conditions	Typical	Maximum	Units
Voltage accuracy	Full load	±2		%
Line regulation	Full load	±1		%
Load regulation	0-100% load	±1		%
Ripple & Noise*	5V, 12V, 15V output		100	mV p-p
	24V output		150	mV p-p
	48V output		250	mV p-p
Remote control	Power ON	≥ 0	0.8	VDC
	Power OFF	≥ 4	10	VDC
Hold up time	230VAC	≥ 16		ms

* Ripple and Noise are measured at 20MHz bandwidth with a 47μF electrolytic capacitor and a 0.1μF ceramic capacitor. Please refer to the application not for specific details.

Isolation Specifications

Parameters	Conditions	Typical	Rated	Units
Tested I/O voltage	60 sec		4000	VAC
Tested Input to GND voltage	60 sec		2000	VAC
Tested Output to GND voltage	60 sec		500	VAC
Resistance (I/O, I/O to GND)*	500VDC		100	MΩ

* Tested under 25±5°C ambient temperature with relative humidity <95% and no condensation.

General Specifications				
Parameters	Conditions	Typical	Maximum	Units
Over Current protection	Constant current limiting, Auto recovery	≥ 105	135	% of I _{out}
Over voltage protection	Output voltage turn off, Manual recovery, 5V output	5.75	6.75	VDC
	Output voltage turn off, Manual recovery, 12V output	13.2	16.2	VDC
	Output voltage turn off, Manual recovery, 15V output	16.5	20.25	VDC
	Output voltage turn off, Manual recovery, 24V output	26.4	32.4	VDC
	Output voltage turn off, Manual recovery, 48V output	52.8	64.8	VDC
Over temperature protection	Shut-down, Auto recovery			
Short circuit protection	Hiccup, Continuous, Auto recovery			
Operating temperature	See derating graph	-30 to +70		°C
Storage temperature		-40 to +85		°C
Power derating	45 °C to 65 °C, 5V output	2		% / °C
	50 °C to 70 °C, others	2		% / °C
	90VAC ~ 100VAC	2		% / VAC
Temperature coefficient	0~50°C	±0.05		% / °C
Cooling	Free air convection			
Humidity	Non-condensing, Storage	≥ 10	95	% RH
	Non-condensing, Operating	≥ 20	90	% RH
Case material	Metal			
Weight		520		g
Dimensions (L x W x H)	7.05 x 3.90 x 1.18inch (179.0 x 99.0 x 30.0mm)			
MTBF	> 280 000 hrs MIL-HDBK-217(25°C)			
NOTE: All specifications in this datasheet are measured at an ambient temperature of 25°C, humidity<75%, nominal input voltage and at rated output load unless otherwise specified.				

Safety Specifications		
Parameters		
Standards	Over voltage category	Design to meet III; According to EN61558, EN50178, EN60664-1, EN62477-1 up to 2000m altitude
	Information technology Equipment	Design to meet UL62368-1, BS EN/EN62368-1, BS EN/EN61558-1
	EMC - Conducted and radiated emission	CISPR32 / EN55032, class B
	Harmonic Current	IEC 61000-3-2
	Flicker	IEC 61000-3-3
	Electrostatic Discharge Immunity	IEC 61000-4-2
	RF, Electromagnetic Field Immunity	IEC 61000-4-3
	Electrical Fast Transient/Burst Immunity	IEC 61000-4-4
	Surge Immunity	IEC 61000-4-5
	RF, Conducted Disturbance Immunity	IEC 61000-4-6
	Power-frequency Magnetic Field	IEC 61000-4-8
Voltage dips, Short Interruptions Immunity	IEC 61000-4-11	

Derating

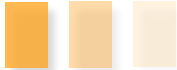

Free Air Convection

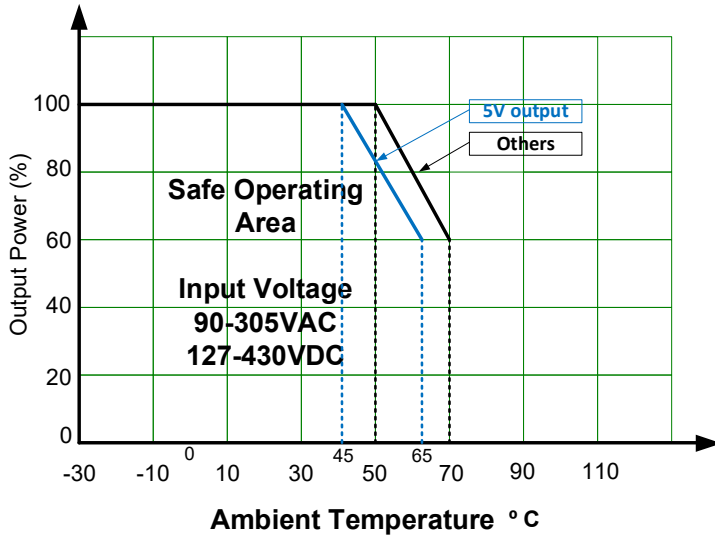

Free Air Convection at 25°C

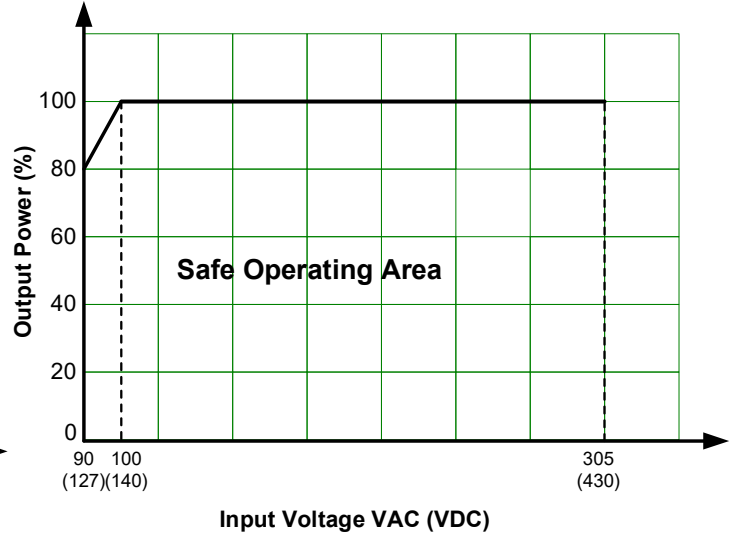

Dimensions

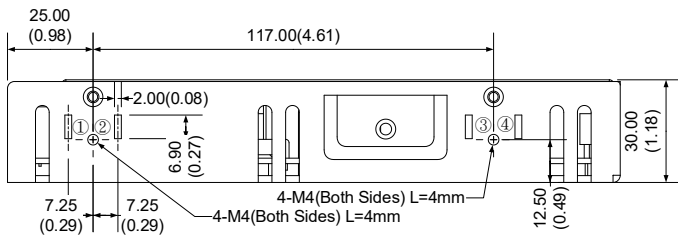
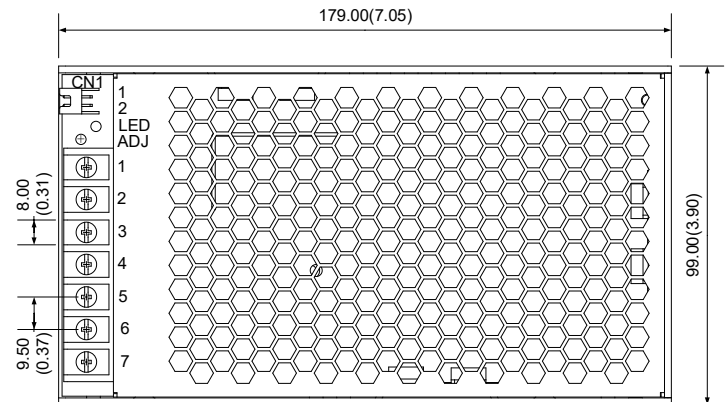
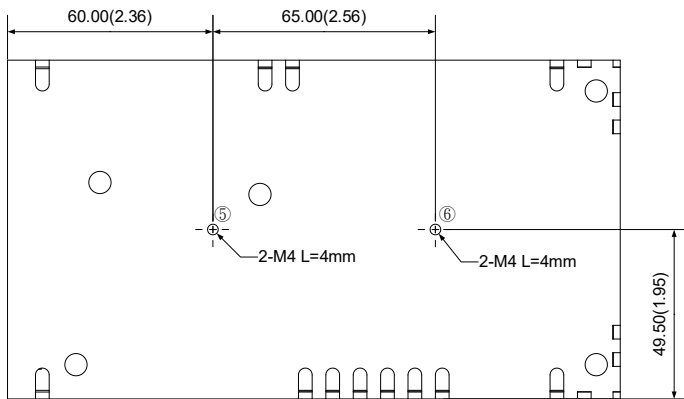

Note:
Unit: mm(inch)
Wire gauge: 22-12AWG
Connector tightening torque: M3.5, 0.8N-m
General tolerance: $\pm 1.0(0.04)$
At least one of the ① - ⑥ location must be connected to PE

Pin Output Specifications

Pin	Single
1	+V Output
2	+V Output
3	-V Output
4	-V Output
5	GND
6	AC Input (N)
7	AC Input (L)

CN1 (JST S2B-XH or equivalent)

Pin	Function	Connector
1	RC+	XH2.54
2	RC-	

NOTE: 1. Datasheets are updated as needed and as such, specifications are subject to change without notice. Once printed or downloaded, datasheets are no longer controlled by Aimtec; refer to www.aimtec.com for the most current product specifications. 2. Product labels shown, including safety agency certifications on labels, may vary based on the date manufactured. 3. Mechanical drawings and specifications are for reference only. 4. All specifications are measured at an ambient temperature of 25°C, humidity<75%, nominal input voltage and at rated output load unless otherwise specified. 5. Aimtec may not have conducted destructive testing or chemical analysis on all internal components and chemicals at the time of publishing this document. CAS numbers and other limited information are considered proprietary and may not be available for release. 6. This product is not designed for use in critical life support systems, equipment used in hazardous environments, nuclear control systems or other such applications which necessitate specific safety and regulatory standards other the ones listed in this datasheet. 7. Warranty is in accordance with Aimtec's standard Terms of Sale available at www.aimtec.com.