

Click to
ORDER
samples

AMES600-NZ



The AMES600-NZ is part of Aimtec’s AC/DC eagle series which offers great cost effectiveness, improved reliability and performance. It features both a universal AC input of 90-132VAC / 180-264VAC as well as a DC input voltage range of 240-370VDC. They offer great EMC performance and are designed to meet EN/UL 62368-1, EN60335-1, EN61558-1 safety standards.

This new series offers great operating temperatures, from -20°C to 65°C and also features an isolation of 3000VAC for improved reliability and system safety. Furthermore, a high MTBF of over 287,600h, output short circuit protection (OSCP), output over-current protection (OCP), output over-voltage protection (OVP) and over-temperature protection (OTP) come standard with the series.

The AMES600-NZ is suitable for grid power, ATM machines, instrumentation, industrial controls, telecommunication and smart home applications.

Features

- Universal Input: 90 - 132VAC/180 – 264VAC or 240-370VDC
- Operating Temp: -20 °C to +65 °C
- High isolation voltage: Up to 3000VAC
- Output short circuit, over-current, over-voltage and over temperature protection.
- Low standby power consumption, high efficiency, low ripple, and noise



Summary

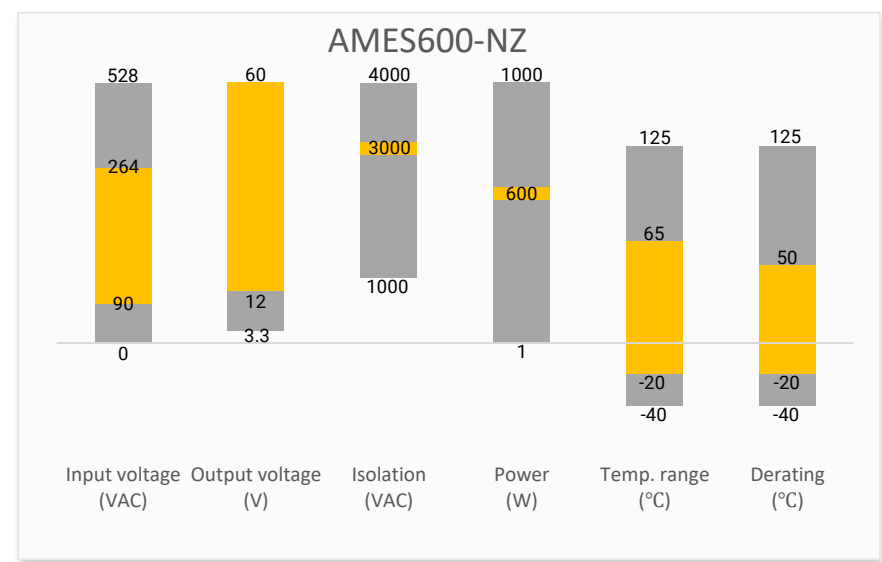

Training



Product Training Video
(click to open)

Press Release

Coming Soon!

Application Notes

Applications



Power Grid Industrial Telecom Instrumentation

Models & Specifications

Single Output

Model	Input Voltage (VAC/VAC/Hz)*	Input Voltage (VDC)**	Max Output Wattage (W)	Output Voltage (V)	Output Voltage Adjustable Range (V)	Output Current max (A)	Maximum capacitive load (μF)	Efficiency @230VAC (%)
AMES600-12SNZ-P	90-132/180-264/47-63	240-370	600	12	11.4-13.2	50	4000	85
AMES600-15SNZ-P	90-132/180-264/47-63	240-370	600	15	14.25-16.5	40	3300	90
AMES600-24SNZ-P	90-132/180-264/47-63	240-370	600	24	22.8-26.4	25	1500	90
AMES600-36SNZ-P	90-132/180-264/47-63	240-370	597.6	36	34.2-39.6	16.6	1500	90
AMES600-48SNZ-P	90-132/180-264/47-63	240-370	600	48	45.6-52.8	12.5	470	89
AMES600-60SNZ-P	90-132/180-264/47-63	240-370	600	60	55.8-66	10	330	92

Note: The "-P" suffix indicates a terminal protective cover and conformal coating (ex. AMES600-12SNZ-P).

* The input voltage needs to be selected by a switch.

** Switch needs to be set to 230V.

Input Specifications

Parameters	Conditions	Typical	Maximum	Units
Input current	115VAC	12		A
	230VAC	7.5		A
Inrush current	230VAC, Cold start	100		A
	115VAC, Cold start	45		A
Leakage current	240VAC		2.5	mA
Start-up Delay Time	115VAC/230VAC, Rated Load	1300		ms

Output Specifications

Parameters	Conditions	Typical	Maximum	Units
Voltage accuracy	Full load, 12V	±1.5		%
	Full load, 15V/24V/36V/48V/60V	±1		%
Line regulation	Rated Load	±0.5		%
Load regulation	Full load, 12V	±1		%
	Full load, 15V/24V/36V/48V/60V	±0.5		%
Ripple & Noise*	12V/15V/24V/36V output		240	mV _{p-p}
	48V/60V output		360	mV _{p-p}
Hold up time	115VAC	16		ms
	230VAC	20		ms

* Ripple and Noise are measured at 20MHz bandwidth with a 47μF electrolytic capacitor and a 0.1μF ceramic capacitor. Please refer to the application note for specific details.

Isolation Specifications

Parameters	Conditions	Typical	Rated	Units
Tested I/O voltage	60 sec		3000	VAC
Tested Input to GND	60 sec		2000	VAC
Tested Output to GND	60 sec		500	VAC
Resistance (I/O, I/O to GND) *	500VDC		100	MΩ

* Tested under 25±5°C ambient temperature with relative humidity <70% and no condensation.

General Specifications				
Parameters	Conditions	Typical	Maximum	Units
Over Current protection	Hiccup, auto recovery	≥ 105	150	% of Iout
Over voltage protection	Hiccup, auto recovery	≥ 115	135	% of Vout
Over temperature protection	Shut-down, manual recovery			
Short circuit protection	Hiccup, Auto recovery			
Stand-by power consumption	12V/48V	5		W
	15V/24V/36V/60V	0.75		W
Operating temperature	See derating graph	-20	65	°C
Storage temperature		-40	85	°C
Power derating	50°C to 65°C	2.67		% / °C
	90VAC-100VAC	2		% / VAC
	180VAC-200VAC	1		% / VAC
Ambient temperature derating	Operating altitude > 2000m	5		°C / 1000m
Temperature coefficient		±0.03		% / °C
Cooling	Forced air cooling			
Humidity	Non-condensing, Storage	≥ 10	95	% RH
	Non-condensing, Operating	≥ 20	90	% RH
Vibration	10~ 500Hz, 5G 10min./1cycle, 60min. each along X, Y, Z axes			
Case material	Metal			
Weight		860		g
Dimensions (L x W x H)	8.86 x 4.88 x 1.61 inch (225.00 x 124.00 x 41.00mm)			
MTBF	> 287 600 hrs (MIL-HDBK -217F, t=+25°C)			
NOTE: All specifications in this datasheet are measured at an ambient temperature of 25°C, humidity<75%, nominal input voltage and at rated output load unless otherwise specified.				

Safety Specifications		
Parameters		
Standards	Information technology Equipment	Designed to meet EN/UL 62368-1, EN60335-1, EN61558-1
	EMC - Conducted and radiated emission	CISPR32 / EN55032, class B, EN55035, EN61000-3-2, EN61000-3-3
	Electrostatic Discharge Immunity	EN 61000-4-2, Criteria A
	RF, Electromagnetic Field Immunity	EN 61000-4-3, Criteria A
	Electrical Fast Transient/Burst Immunity	EN 61000-4-4, Criteria A
	Surge Immunity	EN 61000-4-5, Criteria A
	RF, Conducted Disturbance Immunity	EN 61000-4-6, Criteria A
	MS	EN 61000-4-8, Criteria A
	Voltage dips, Short Interruptions Immunity	EN 61000-4-11, Criteria B

Derating

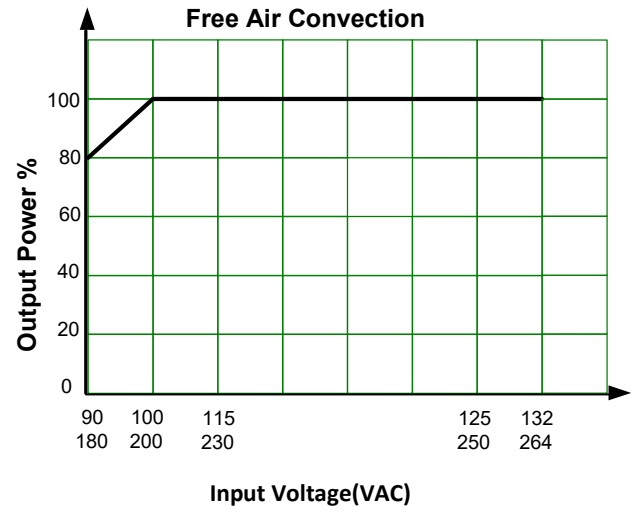
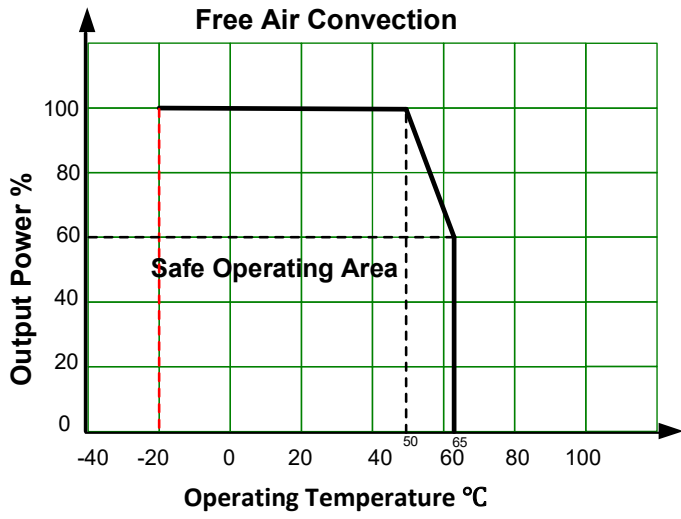

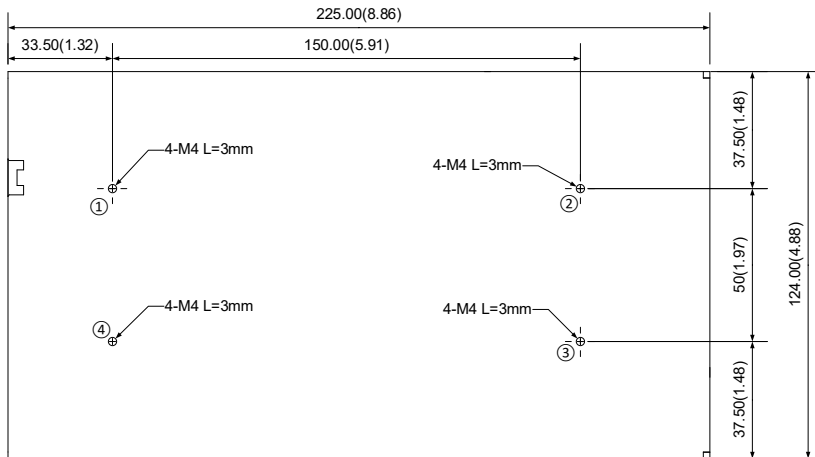

Dimensions

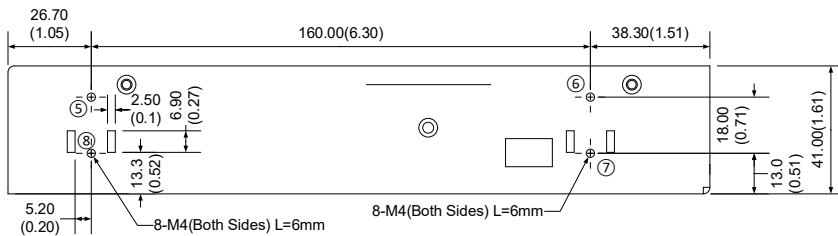

Pin Output Specifications	
Pin	Single
1	+V Output
2	+V Output
3	+V Output
4	-V Output
5	-V Output
6	-V Output
7	GND
8	AC Input (N)
9	AC Input (L)

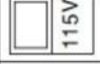

Switch	AC Input	DC Input
 115V	90-132VAC	---
 230V	180-264VAC	240-373VDC

Screw Spec.	L(max)	Torque(max)
M4	5mm	0.9N · m
M4	3mm	0.9N · m

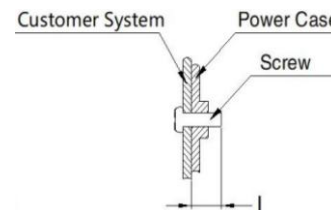
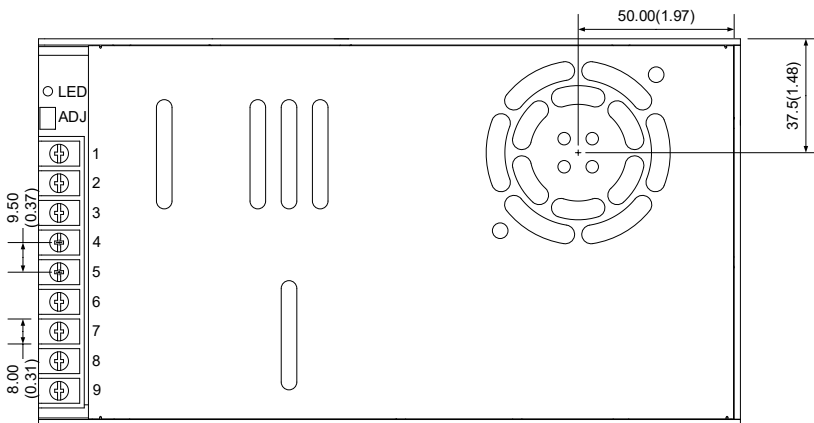

Note:
Unit: mm(inch)
ADJ: Output adjustable resistor
Wire gauge: 22-12AWG
Connector tightening torque: M3.5, 0.8N-m
General tolerance: $\pm 1.0(0.04)$
At least one of the ① - ⑧ location must be connected to PE

NOTE: 1. Datasheets are updated as needed and as such, specifications are subject to change without notice. Once printed or downloaded, datasheets are no longer controlled by Aimtec; refer to www.aimtec.com for the most current product specifications. 2. Product labels shown, including safety agency certifications on labels, may vary based on the date manufactured. 3. Mechanical drawings and specifications are for reference only. 4. All specifications are measured at an ambient temperature of 25°C, humidity<75%, nominal input voltage and at rated output load unless otherwise specified. 5. Aimtec may not have conducted destructive testing or chemical analysis on all internal components and chemicals at the time of publishing this document. CAS numbers and other limited information are considered proprietary and may not be available for release. 6. This product is not designed for use in critical life support systems, equipment used in hazardous environments, nuclear control systems or other such applications which necessitate specific safety and regulatory standards other the ones listed in this datasheet. 7. Warranty is in accordance with Aimtec's standard Terms of Sale available at www.aimtec.com.