

Click to
ORDER
samples

AMEOF5-277EZ

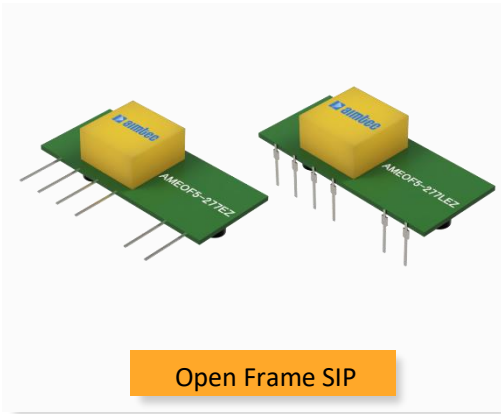

The AMEOF5-277EZ is a compact open frame AC/DC converter that offers an input voltage range of 85-305VAC.

Aimtec's AMEOF5-277EZ features low power consumption, high efficiency & reliability, and 3000VAC isolation. It is also designed to meet the IEC/UL62368-1 standards, which makes it suitable for many industrial applications such as controls and instrumentation.

Features



- Input: 85-305VAC, 100-430VDC
- I/O Isolation 3000VAC
- Short circuit protection
- Operating Temp: -20 to +70°C
- Low power consumption $\leq 0.15W$
- Compact open frame SIP
- Over current protection
- Made in Taiwan

Summary

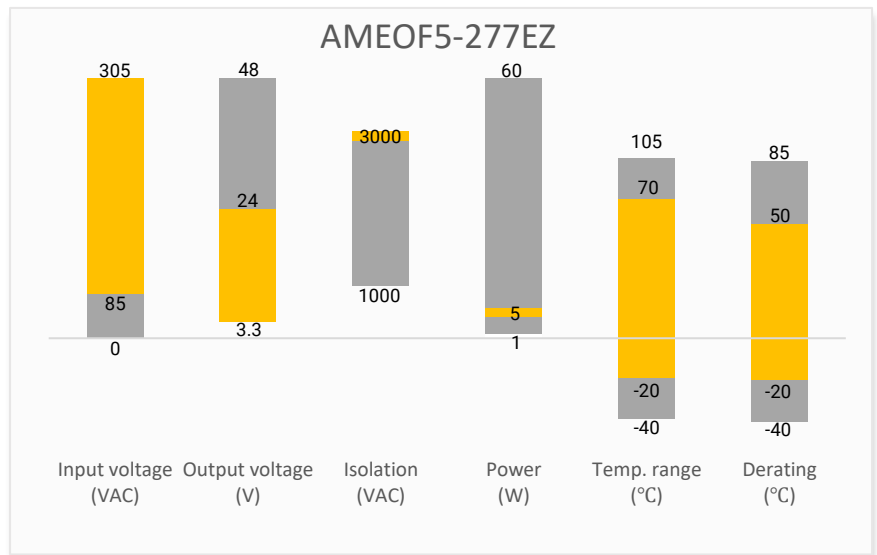

Training

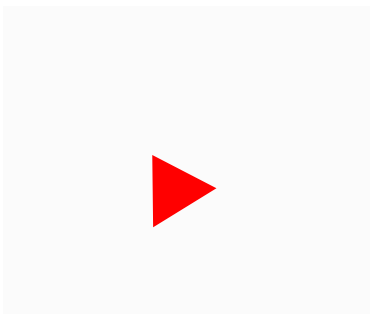

Product Training Video
(click to open)



Press Release

Application Notes

Applications



Industrial



Automation



Test Equipment

Models & Specifications

Single Output Straight Pins

Model	Input Voltage (VAC/Hz)	Input Voltage (VDC)	Full power temperature range (°C)	Output Voltage (V)	Output Current max (mA)	Maximum capacitive Load (μF)	Efficiency (%)
AMEOF5-3S277EZ	85-305/47-63	100-430	-20 to +50	3.3	1000	2200	69
AMEOF5-5S277EZ	85-305/47-63	100-430	-20 to +50	5	1000	1500	76
AMEOF5-9S277EZ	85-305/47-63	100-430	-20 to +50	9	560	680	77
AMEOF5-12S277EZ	85-305/47-63	100-430	-20 to +50	12	420	470	79
AMEOF5-15S277EZ	85-305/47-63	100-430	-20 to +50	15	340	330	79
AMEOF5-24S277EZ	85-305/47-63	100-430	-20 to +50	24	210	100	81

Single Output Bent Pins

Model	Input Voltage (VAC/Hz)	Input Voltage (VDC)	Full power temperature range (°C)	Output Voltage (V)	Output Current max (mA)	Maximum capacitive Load (μF)	Efficiency (%)
AMEOF5-3SL277EZ	85-305/47-63	100-430	-20 to +50	3.3	1000	2200	69
AMEOF5-5SL277EZ	85-305/47-63	100-430	-20 to +50	5	1000	1500	76
AMEOF5-9SL277EZ	85-305/47-63	100-430	-20 to +50	9	560	680	77
AMEOF5-12SL277EZ	85-305/47-63	100-430	-20 to +50	12	420	470	79
AMEOF5-15SL277EZ	85-305/47-63	100-430	-20 to +50	15	340	330	79
AMEOF5-24SL277EZ	85-305/47-63	100-430	-20 to +50	24	210	100	81

Input Specification

Parameters	Conditions	Typical	Maximum	Units
Input current	115VAC		200	mA
	230VAC		100	mA
Inrush current	115VAC	13		A
	230VAC	23		A
Input dissipation	No Load	0.1	0.15	W

Output Specification

Parameters	Conditions	Typical	Maximum	Units
Voltage accuracy	3.3Vout		±8	%
	Others		±5	%
Line regulation	Full load, main input range	±1.5		%
Load regulation	10-100% load	±2.5		%
Minimum load		10		% of Iout
Ripple & Noise*		80	150	mV p-p

* 20MHz bandwidth with a 0.1uF CC and a 10uF EC

Isolation Specifications				
Parameters	Conditions	Typical	Rated	Units
Tested I/O voltage	5 sec / 5 mA		3000	VAC
Isolation Resistance I/O	500VDC	>100		MΩ

General Specifications				
Parameters	Conditions	Typical	Maximum	Units
Switching frequency		60		KHz
Over current protection	Auto-recovery	>110		% of I out
Short circuit protection	Auto-recovery			
Operating temperature	See derating curve	-20 to +70		°C
Storage temperature		-40 to +105		°C
Cooling	Free air convection			
Humidity			85	% RH
Weight		6.5		g
Dimensions (L x W x H)	1.65 x 0.54 x 0.79 inches 42.00 x 13.65 x 20.00 mm			

NOTE: All specifications in this datasheet are measured at an ambient temperature of 25°C, humidity<75%, nominal input voltage and at rated output load unless otherwise specified.

Safety Specifications		
Parameters		
Standards	Information technology Equipment	Design to meet UL62368-1, IEC62368-1
	EMC - Conducted and radiated emission	EN55032, CLASS B, See EMC Recommended Circuit
	EMS Immunity	EN 61000, See EMC Recommended Circuit

Derating

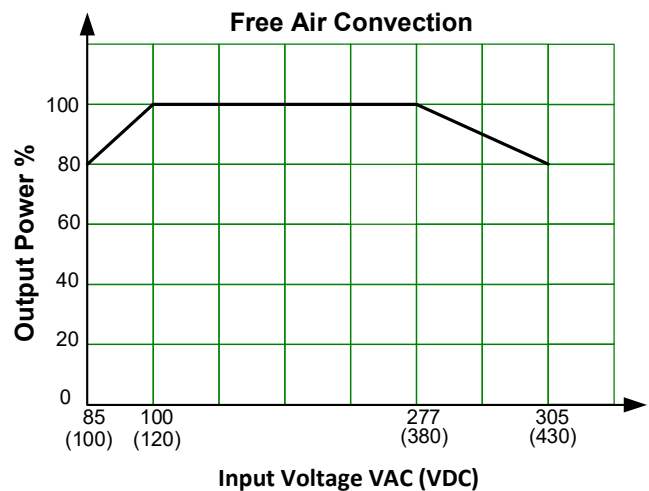
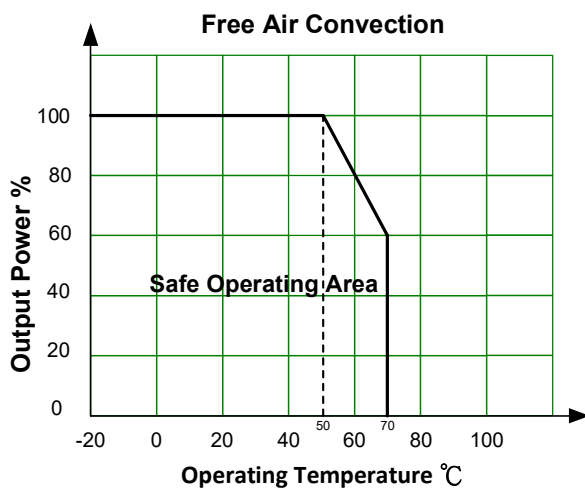

EMC Recommended Circuit

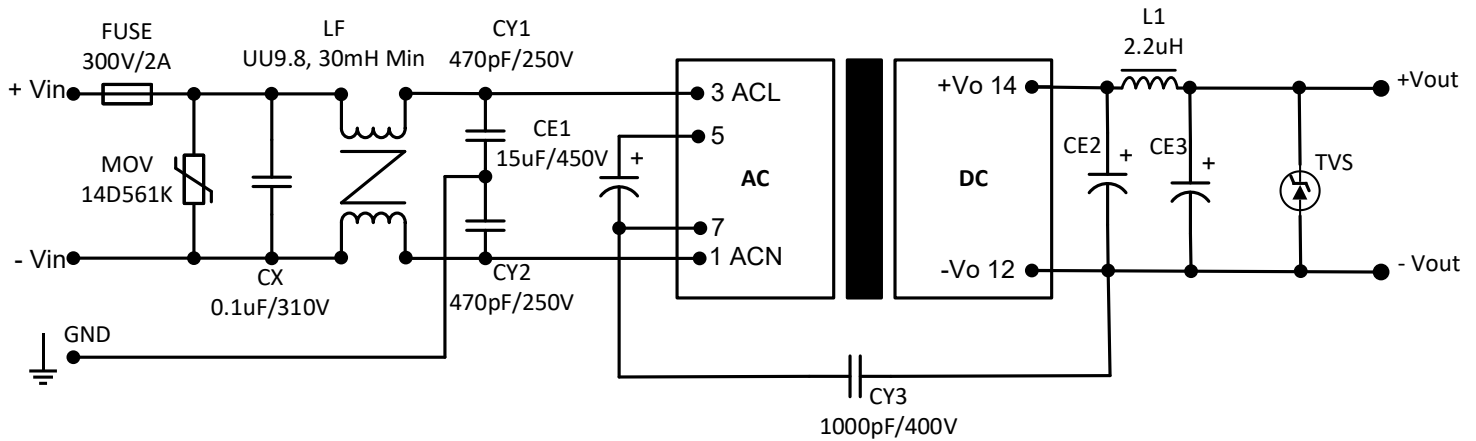

Model	CE2	CE3	TVS
3.3 Vout	820uF/10V	470uF/10V	SMBJ7.0A
5 Vout	820uF/10V	470uF/10V	SMBJ7.0A
9 Vout	470uF/25V	220uF/35V	SMBJ12A
12 Vout	470uF/25V	220uF/35V	SMBJ20A
15 Vout	470uF/25V	220uF/35V	SMBJ20A
24 Vout	330uF/35V	220uF/35V	SMBJ30A

It is recommended that solid-state capacitors be used as the capacitor material for CE2.

Dimensions

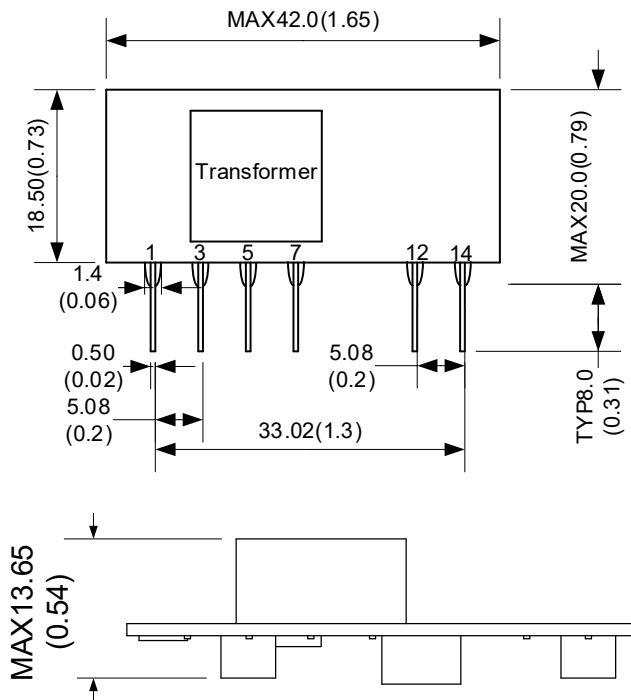

Pin Out Specifications	
Pin	Single
1	ACN
3	ACL
5	+V (cap)
7	-V (cap)
12	-V Output
14	+V Output

Note:
Unit: mm(inch)
General tolerances: $\pm 0.5(\pm 0.02)$

L Model Dimension

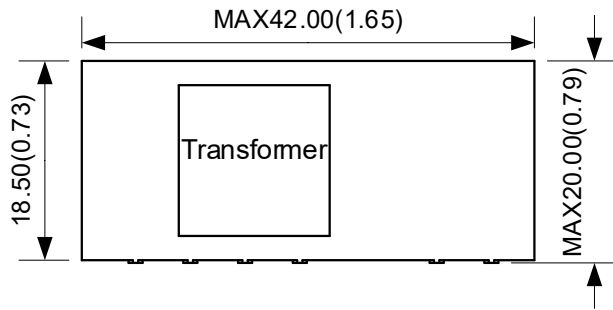

Pin Out Specifications	
Pin	Single
1	ACN
3	ACL
5	+V (cap)
7	-V (cap)
12	-V Output
14	+V Output

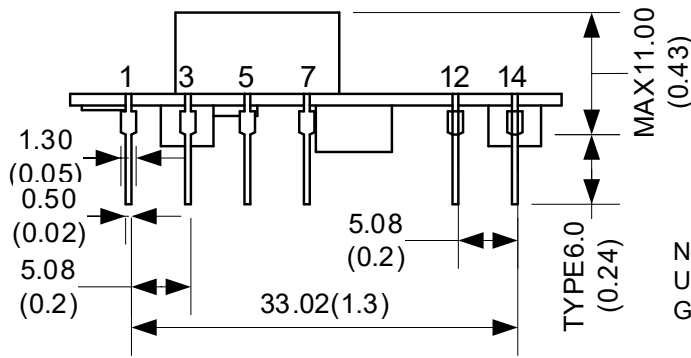

Note:
Unit: mm(inch)
General tolerances: $\pm 0.5(\pm 0.02)$

NOTE: **1.** Datasheets are updated as needed and as such, specifications are subject to change without notice. Once printed or downloaded, datasheets are no longer controlled by Aimtec; refer to www.aimtec.com for the most current product specifications. **2.** Product labels shown, including safety agency certifications on labels, may vary based on the date manufactured. **3.** Mechanical drawings and specifications are for reference only. **4.** All specifications are measured at an ambient temperature of 25°C, humidity<75%, nominal input voltage and at rated output load unless otherwise specified. **5.** Aimtec may not have conducted destructive testing or chemical analysis on all internal components and chemicals at the time of publishing this document. CAS numbers and other limited information are considered proprietary and may not be available for release. **6.** This product is not designed for use in critical life support systems, equipment used in hazardous environments, nuclear control systems or other such applications which necessitate specific safety and regulatory standards other the ones listed in this datasheet. **7.** Warranty is in accordance with Aimtec's standard Terms of Sale available at www.aimtec.com.