

Click to
ORDER
samples

AMEOF3-277EZ

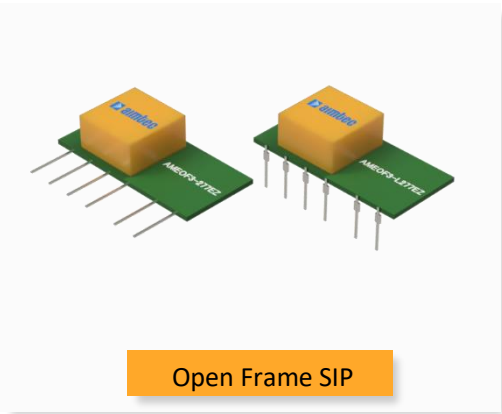

The AMEOF3-277EZ is a compact open frame AC/DC converter that offers an input voltage range of 85-305VAC.

Aimtec's AMEOF3-277EZ features low power consumption, high efficiency & reliability, and 3000VAC isolation. It also meets the IEC/UL/EN62368-1 standards, which makes it suitable for many industrial applications such as controls and instrumentation.

Features

- Input: 85-305VAC, 70-430VDC
- I/O Isolation 3000VAC
- Short circuit protection
- Operating Temp: -40 to +85°C
- Low power consumption $\leq 0.5W$
- Compact open frame SIP
- Over current protection
- Made in Taiwan

Summary

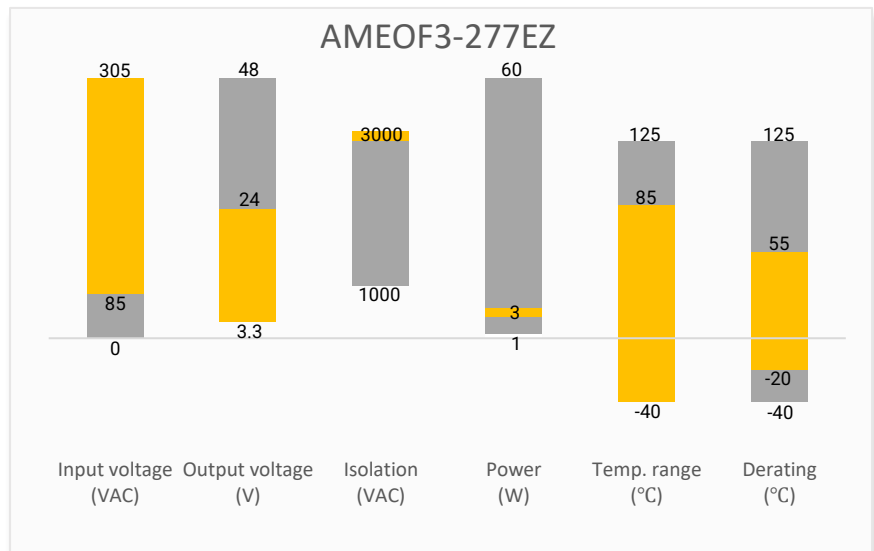

Training

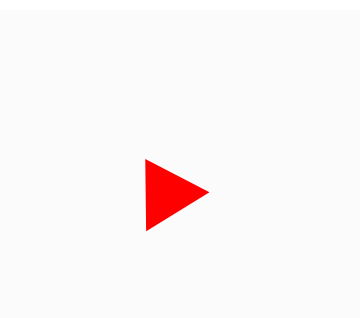

Product Training Video
(click to open)



Press Release

Application Notes

Applications



Industrial Automation Test Equipment

Models & Specifications

Single Output Straight Pins

Model	Input Voltage (VAC/Hz)	Input Voltage (VDC)	Full power temperature range (°C)	Output Voltage (V)	Output Current max (mA)	Maximum capacitive Load (μF)	Efficiency (%)
AMEOF3-3S277EZ	85-305/47-63	70-430	-20 to +55	3.3	500	800	67
AMEOF3-5S277EZ	85-305/47-63	70-430	-20 to +55	5	500	800	68
AMEOF3-9S277EZ	85-305/47-63	70-430	-20 to +55	9	333	600	75
AMEOF3-12S277EZ	85-305/47-63	70-430	-20 to +55	12	250	470	77
AMEOF3-15S277EZ	85-305/47-63	70-430	-20 to +55	15	200	470	78
AMEOF3-24S277EZ	85-305/47-63	70-430	-20 to +55	24	125	120	80

Single Output Bent Pins

Model	Input Voltage (VAC/Hz)	Input Voltage (VDC)	Full power temperature range (°C)	Output Voltage (V)	Output Current max (mA)	Maximum capacitive Load (μF)	Efficiency (%)
AMEOF3-3SL277EZ	85-305/47-63	70-430	-20 to +55	3.3	500	800	67
AMEOF3-5SL277EZ	85-305/47-63	70-430	-20 to +55	5	500	800	68
AMEOF3-9SL277EZ	85-305/47-63	70-430	-20 to +55	9	333	600	75
AMEOF3-12SL277EZ	85-305/47-63	70-430	-20 to +55	12	250	470	77
AMEOF3-15SL277EZ	85-305/47-63	70-430	-20 to +55	15	200	470	78
AMEOF3-24SL277EZ	85-305/47-63	70-430	-20 to +55	24	125	120	80

Input Specification

Parameters	Conditions	Typical	Maximum	Units
Current	115VAC		100	mA
	230VAC		50	mA
Inrush current	115VAC	10		A
	230VAC	15		A
Input dissipation	No Load		0.5	W

Output Specification

Parameters	Conditions	Typical	Maximum	Units
Voltage accuracy			±5	%
Line regulation	Full load, main input range	±1.5		%
Load regulation	5-100% load	±3.5		%
Minimum load		0		A
Ripple & Noise*	3.3~5V Output	50	150	mV p-p
	9~24V Output	80	150	mV p-p

* 20MHz bandwidth with a 0.1uF CC and a 10uF EC

Isolation Specifications

Parameters	Conditions	Typical	Rated	Units
Tested I/O voltage	5 sec / 5 mA		3000	VAC
Isolation Resistance	500VDC	>100		MΩ

General Specifications

Parameters	Conditions	Typical	Maximum	Units
Switching frequency			60	KHz
Over current protection	Auto-recovery	>110		% of I out
Short circuit protection	Auto-recovery			
Operating temperature	See derating curve	-40 to +85		°C
Storage temperature		-40 to +105		°C
Cooling	Free air convection			
Humidity			85	% RH
Weight		4.8		g
Dimensions (L x W x H)	1.38 x 0.71 x 0.43 inches 35.0 x 18.0 x 11.00 mm			

NOTE: All specifications in this datasheet are measured at an ambient temperature of 25°C, humidity<75%, nominal input voltage and at rated output load unless otherwise specified.

Safety Specifications

Parameters		
Standards	Information technology Equipment	Design to meet UL62368-1, IEC62368-1
	EMC - Conducted and radiated emission	EN55032, CLASS B, See EMC Recommended Circuit
	EMS Immunity	IEC 61000, See EMC Recommended Circuit

Derating

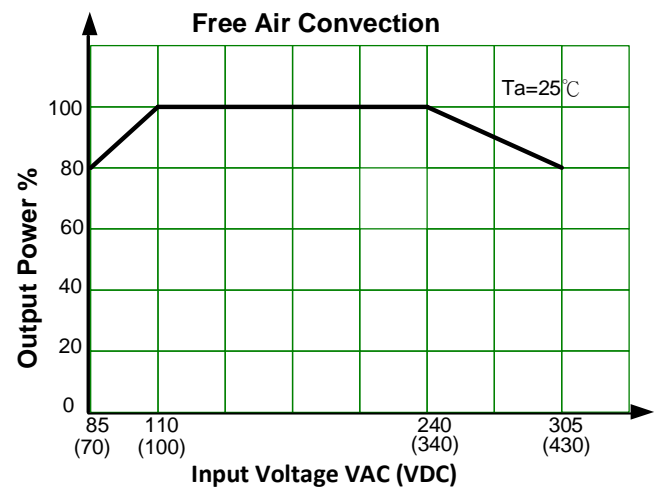
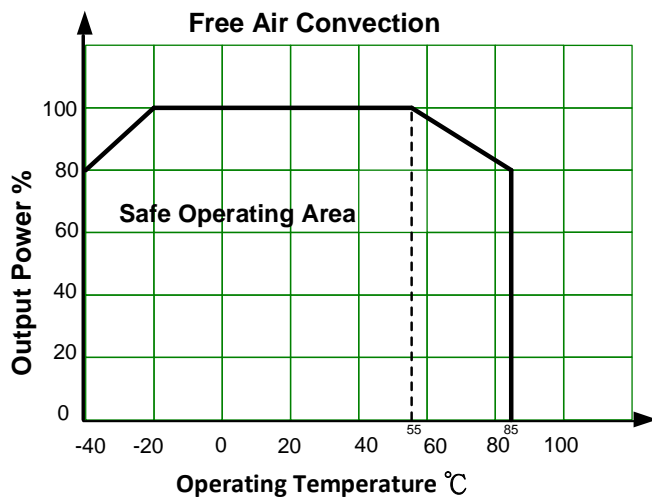

EMC Recommended Circuit

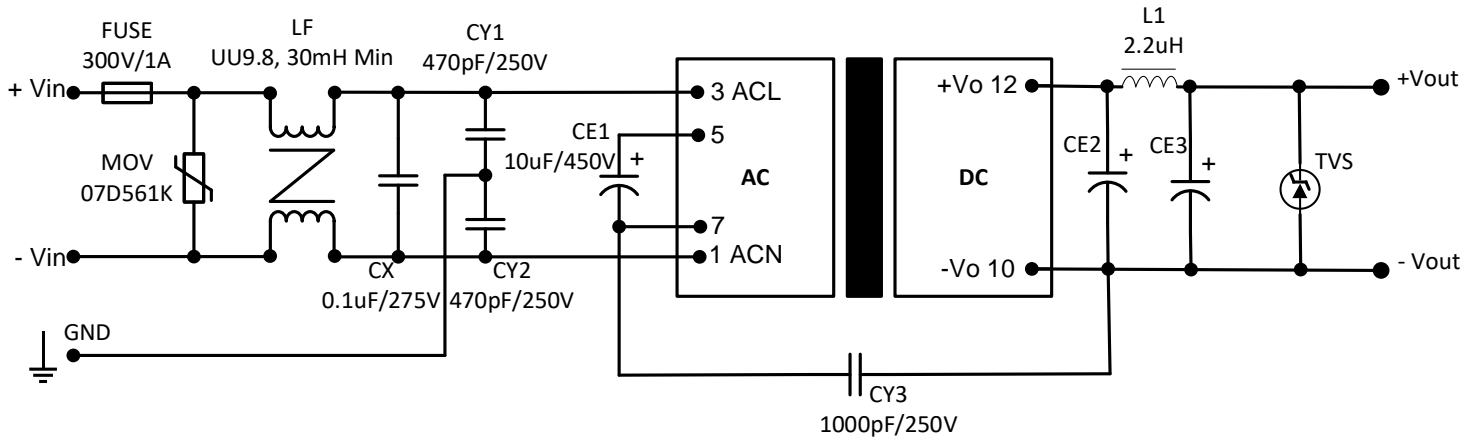

Model	CE2	CE3	TVS
3.3 Vout	330uF/35V	220uF/35V	SMBJ7.0A
5 Vout	330uF/35V	220uF/35V	SMBJ7.0A
9 Vout	220uF/35V	68uF/35V	SMBJ12A
12 Vout	220uF/35V	68uF/35V	SMBJ20A
15 Vout	220uF/35V	68uF/35V	SMBJ20A
24 Vout	68uF/35V	68uF/35V	SMBJ30A

Dimensions

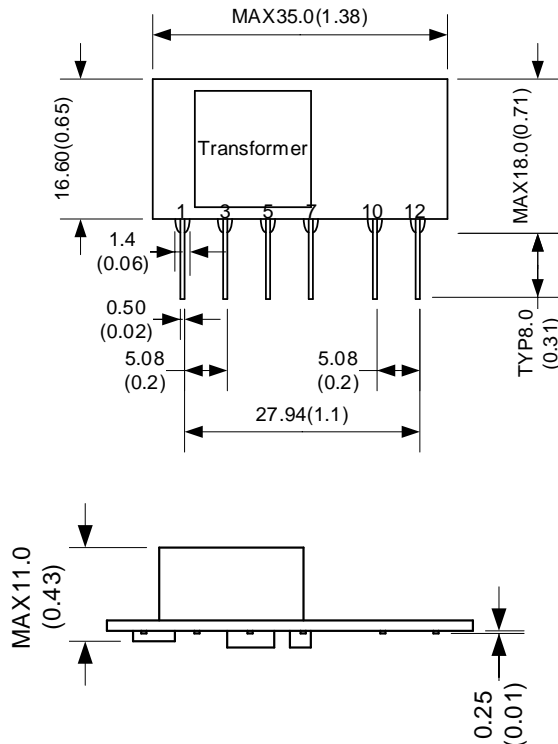

Pin Out Specifications

Pin	Single
1	ACN
3	ACL
5	+V (cap)
7	-V (cap)
10	-V Output
12	+V Output

Note:
Unit: mm(inch)
General tolerances: $\pm 0.5(\pm 0.02)$

L Model Dimensions

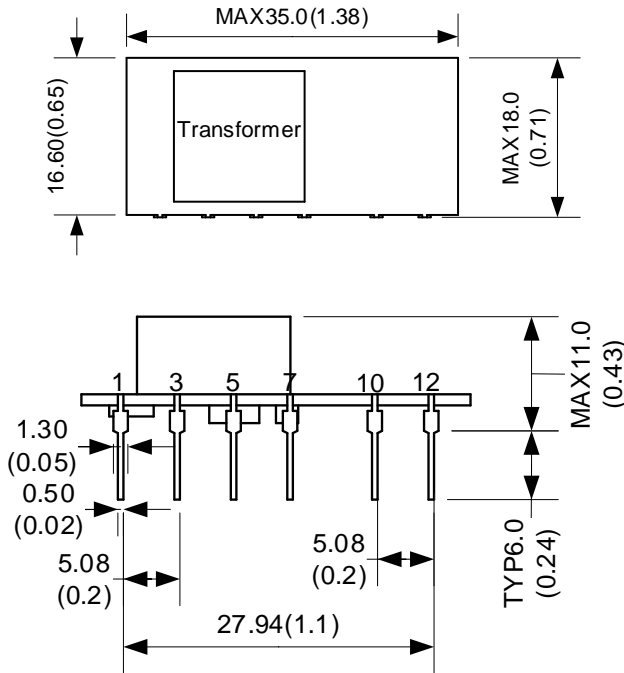

Pin Out Specifications	
Pin	Single
1	ACN
3	ACL
5	+V (cap)
7	-V (cap)
10	-V Output
12	+V Output

Note:
Unit: mm(inch)
General tolerances: $\pm 0.5(\pm 0.02)$

NOTE: 1. Datasheets are updated as needed and as such, specifications are subject to change without notice. Once printed or downloaded, datasheets are no longer controlled by Aimtec; refer to www.aimtec.com for the most current product specifications. 2. Product labels shown, including safety agency certifications on labels, may vary based on the date manufactured. 3. Mechanical drawings and specifications are for reference only. 4. All specifications are measured at an ambient temperature of 25°C, humidity<75%, nominal input voltage and at rated output load unless otherwise specified. 5. Aimtec may not have conducted destructive testing or chemical analysis on all internal components and chemicals at the time of publishing this document. CAS numbers and other limited information are considered proprietary and may not be available for release. 6. This product is not designed for use in critical life support systems, equipment used in hazardous environments, nuclear control systems or other such applications which necessitate specific safety and regulatory standards other the ones listed in this datasheet. 7. Warranty is in accordance with Aimtec's standard Terms of Sale available at www.aimtec.com.