

## AMED240N-GY



DIN Rail

The AMED240N-GY is a DIN rail AC/DC converter that features a cost-effective power supply design. Offering a commercial input voltage range of 90-264VAC and an output voltage range from 24-48V, this series will offer many benefits to your new system design. It measures 63.00 x 125.00 x 113.50mm and has ambient air-cooling vents both at the top and bottom of the converter for improved thermal performance. It is also easy to install and remove for maintenance, while efficiently organizing all your electrical cables.

This new series offers great operating temperatures, from -20°C to 70°C and features an isolation of 3000VAC for improved reliability and system safety. Furthermore, a high MTBF of 1,398,400h, output over-load protection, output short circuit protection, over temperature protection (OTP), and output over-voltage protection (OVP) come standard with the series. A built in DC OK relay contact also comes standard with the series.

The AMED240N-GY is suitable for electric distribution boxes, grid power, instrumentation, CNC machines, industrial control panels and building automation applications.

## Features

- Universal Input: 90 - 264VAC/127 - 370VDC
- Operating Temp: -20 °C to +70 °C
- High isolation voltage: 3000VAC
- Low ripple & noise: 150mV(p-p), max.
- Short circuit protection, over-voltage protection, overload protection, and over-temperature protection

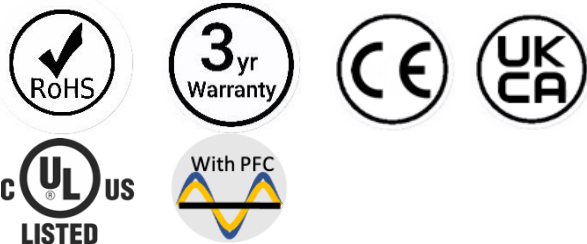

## Summary

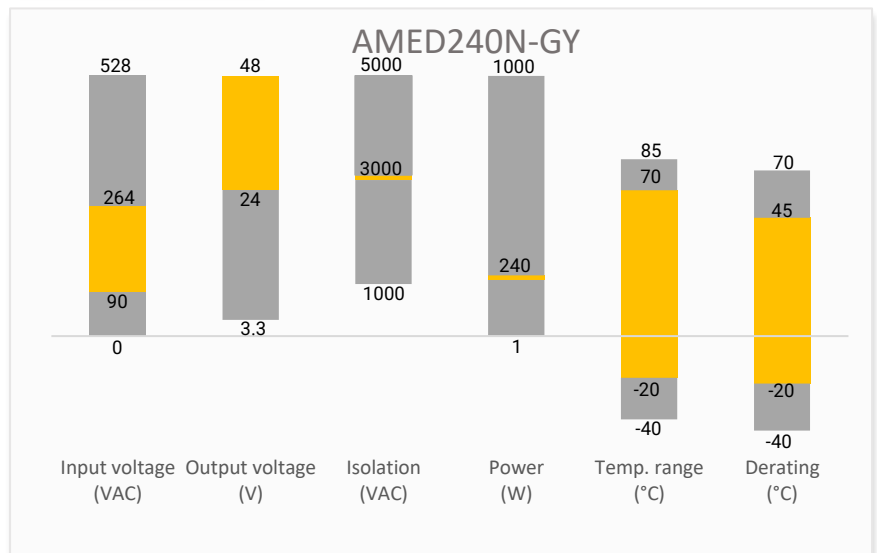

## Training



Product Training Video  
(click to open)

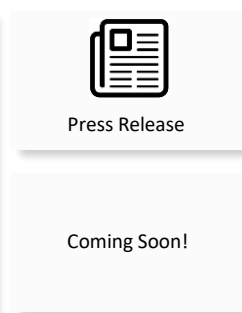

Application Notes

## Applications



Power Grid



Industrial



Telecom

## Models & Specifications

Model	Input Voltage (VAC/Hz)	Input Voltage (VDC)	Max Output wattage (W)	Output Voltage (V)	Output Current max (A)	Efficiency Typ. (%)
AMED240N-24SGY	90~264/47~63	127~370	240	24	10	87
AMED240N-48SGY	90~264/47~63	127~370	240	48	5	88

### Input Specifications

Parameters	Conditions	Typical	Maximum	Units
Input Current	115VAC		2.5	A
	230VAC		1.3	A
Inrush Current	115VAC, cold start	37.2		A
	230VAC, cold start	70.0		A
Leakage Current	240VAC	<1.0		mA
Power Factor	115VAC at full load	>0.98		
	230VAC at full load	>0.95		

### Output Specifications

Parameters	Conditions	Typical	Maximum	Units
Voltage accuracy	0 - 100% load	± 2		%
Line regulation	Rated load	± 0.5		%
Load regulation	0 - 100% load	± 1		%
Ripple & Noise*			150	mV p-p
Start-up time	230VAC input, full load		3.0	s
	115VAC input, full load		1.5	s
Rise time	230VAC input, full load		100	ms
	115VAC input, full load		100	ms
Hold up time	230VAC input, full load	16		ms
	115VAC input, full load	12		ms
Voltage adjustable range	24 VDC Output	24 - 28		V
	48 VDC Output	48 - 55		V

\* Ripple and Noise are measured at 20MHz bandwidth. Please refer to the application note for specific details. Measured with a 47μF electrolytic capacitor and a 0.1μF ceramic capacitor.

### Isolation Specifications

Parameters	Conditions	Typical	Maximum	Units
Tested I/O voltage	60 sec, Leakage current < 10mA	3000		VAC
Tested Input to GND voltage	60 sec, Leakage current < 10mA	2000		VAC
Tested Output to GND voltage	60 sec, Leakage current < 10mA	500		VAC
Insulation resistance	500VDC	>100		MΩ

General Specifications				
Parameters	Conditions	Typical	Maximum	Units
Over voltage protection	24 VDC Output, manual-recovery	≤ 33		VDC
	48 VDC Output, manual-recovery	≤ 65		VDC
Over temperature protection	Shuts down output voltage, auto-recovery			
Overload protection	105 ~ 130% rated output power, hiccup mode, auto-recovery			
Short circuit protection	Hiccup, auto-recovery			
Operating temperature	20 ~ 95% RH	-20 to +70		°C
Storage temperature	10 ~ 95% RH	-40 to +85		°C
Power derating	230VAC, 50 °C to 70 °C	2.5		% / °C
	90 to 100 VAC	2		% / VAC
Cooling	Free air convection			
Storage Humidity	Non-condensing	>10	95	% RH
Operating Humidity	Non-condensing	>20	95	% RH
Case material	Metal			
Weight		1000		g
Dimensions (L x W x H)	2.48 x 4.92 x 4.47 inches (63.00 x 125.00 x 113.50 mm)			
MTBF	1398.4K hrs min. Telcordia SR-332 (Bellcore)			
NOTE: All specifications in this datasheet are measured at an ambient temperature of 25°C, humidity<75%, nominal input voltage and at rated output load unless otherwise specified.				

Safety Specifications		
Parameters		
Agency approval	UL508, BS EN/EN62368-1	
Standards	EMC - Conducted and radiated emission	CISPR32 / EN55032, Class B
	Harmonic Current emission	IEC/EN 61000-3-2, Class A
	Voltage Fluctuations & Flicker	IEC/EN 61000-3-3
	Electrostatic Discharge Immunity	IEC/EN 61000-4-2 Contact ±4KV, Air ±8KV, Criteria B
	RF, Electromagnetic Field Immunity	IEC/EN 61000-4-3 3V/m, Criteria A
	Electrical Fast Transient/Burst Immunity	IEC/EN 61000-4-4 ±1KV, Criteria B
	Surge Immunity	IEC/EN 61000-4-5 L-L ±1KV, L-G ±2KV, Criteria B
	CS, Conducted Disturbance Immunity	IEC/EN 61000-4-6 3V, 3V~1V, 1V r.m.s, Criteria A
	Power Frequency Magnetic Field Immunity	IEC/EN 61000-4-8 50, 60Hz, Criteria A
	Voltage dips, Short Interruptions Immunity	IEC/EN 61000-4-11 100% Voltage Dips/Interruptions, 3 cycles, Criteria B
	EMC Immunity	BS EN/EN55035, BS EN/EN61000-6-2(BS EN/EN50082-2)

**Derating**

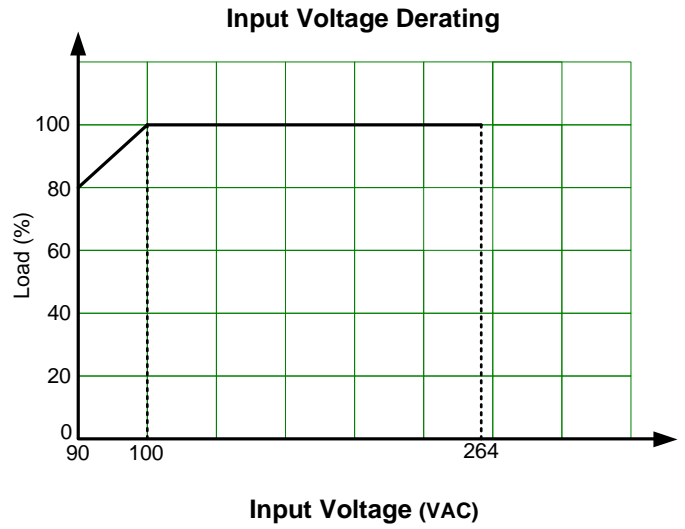
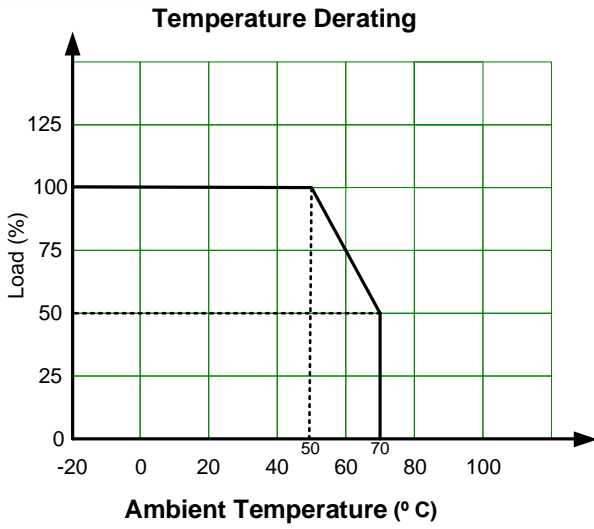

**Dimensions**

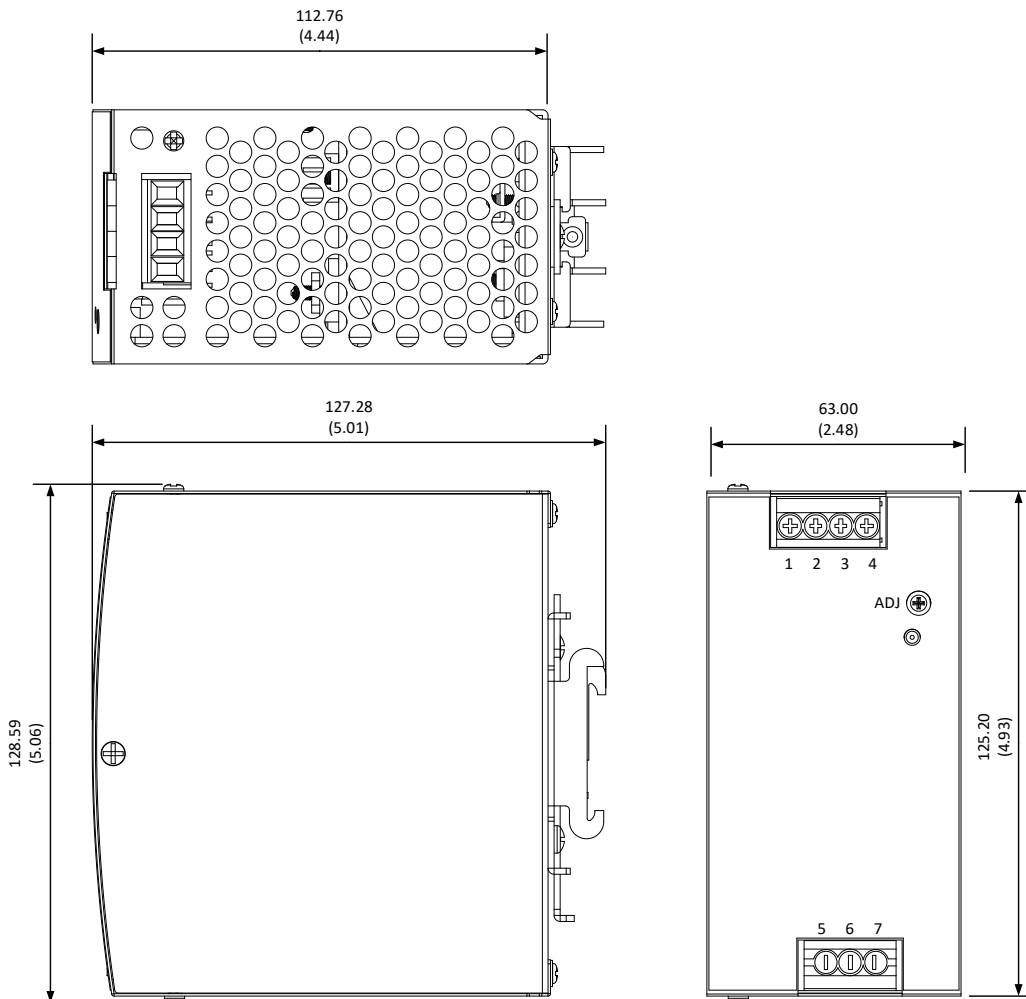

Pin Output Specifications	
Pin	Function
1	-V Output
2	-V Output
3	+V Output
4	+V Output
5	GND $\perp$
6	N
7	L
ADJ	Voltage Adjustment

## Functional Diagram

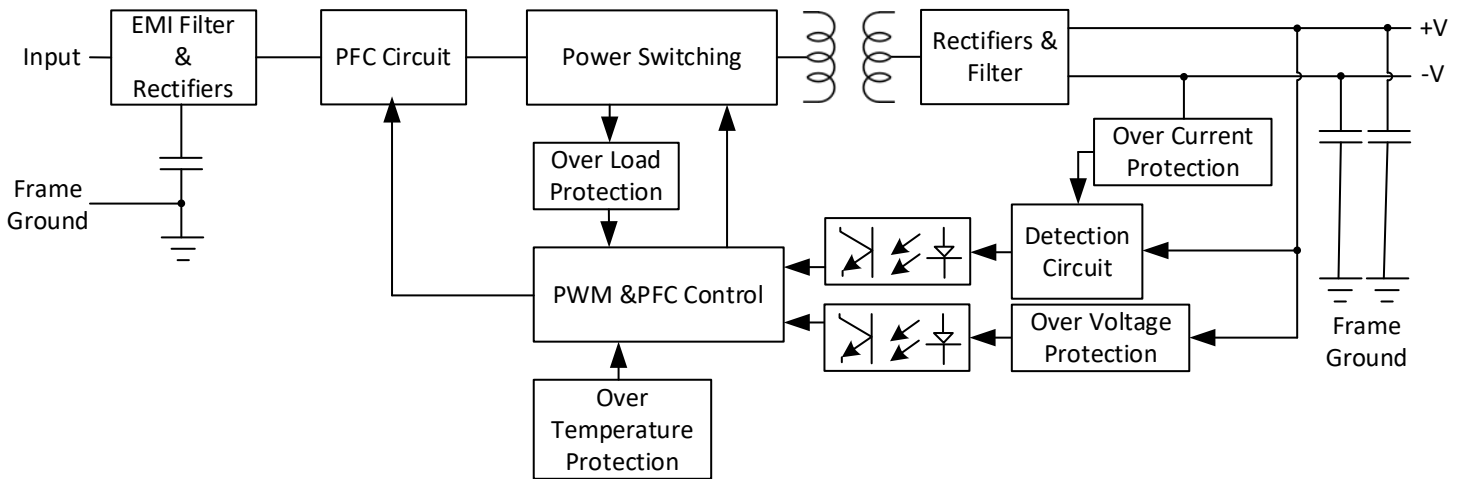

**NOTE:** 1. Datasheets are updated as needed and as such, specifications are subject to change without notice. Once printed or downloaded, datasheets are no longer controlled by Aimtec; refer to [www.aimtec.com](http://www.aimtec.com) for the most current product specifications. 2. Product labels shown, including safety agency certifications on labels, may vary based on the date manufactured. 3. Mechanical drawings and specifications are for reference only. 4. All specifications are measured at an ambient temperature of 25°C, humidity<75%, nominal input voltage and at rated output load unless otherwise specified. 5. Aimtec may not have conducted destructive testing or chemical analysis on all internal components and chemicals at the time of publishing this document. CAS numbers and other limited information are considered proprietary and may not be available for release. 6. This product is not designed for use in critical life support systems, equipment used in hazardous environments, nuclear control systems or other such applications which necessitate specific safety and regulatory standards other the ones listed in this datasheet. 7. Warranty is in accordance with Aimtec's standard Terms of Sale available at [www.aimtec.com](http://www.aimtec.com).