

Click to  
**ORDER**  
samples

AME25-277LPZ



The AME25-277LPZ is a whole new AC/DC converter that offers much greater cost effectiveness due to material normalization and production automation also leading to improved reliability and performance. Offering a commercial input voltage range of 85-305VAC and an output voltage range from 3.3-24V, this series will offer many benefits to your new system design.

This new series offers great operating temperatures from -40°C to 85°C, also features an isolation of 4200VAC for improved reliability and system safety. Furthermore, a higher MTBF of 1,000,000h, output short circuit protection (OSCP), output over-current protection (OCP) and an output over-voltage protection (OVP) come standard with the series.

The AME25-277LPZ is suitable for street lighting controls, grid power, EVSE, industrial controls, UPS, battery storage system and energy management applications.

Features

- Universal Input: 85 - 305VAC/100 - 430VDC
- Operating Temp: -40 °C to +85 °C
- High isolation voltage: 4200VAC
- Low ripple & noise, 50mV(p-p), typ.
- Output short circuit, over-current, over-voltage protection
- Regulated Output



Summary

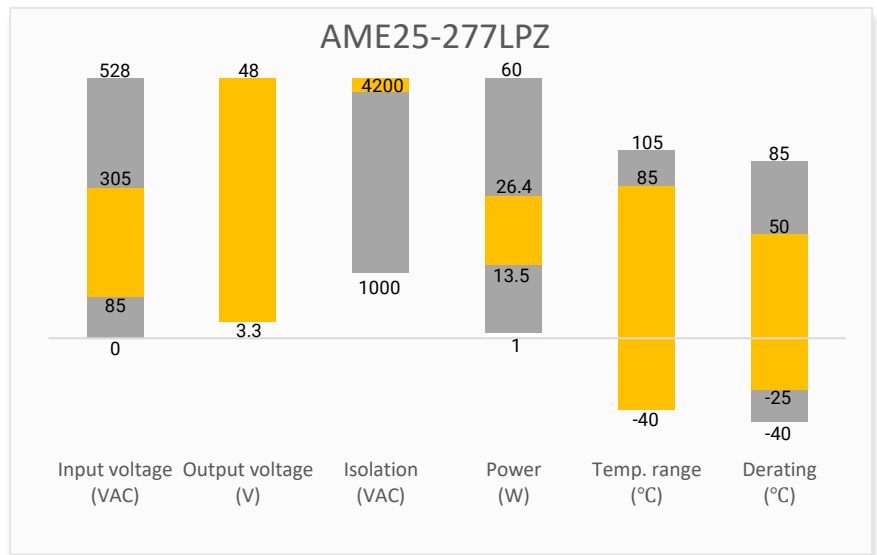

Training



Product Training Video  
(click to open)

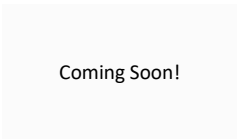

Application Notes

Applications



Power Grid



Industrial



Telecom



Instrumentation

## Models & Specifications

### Single Output

Model	Input Voltage (VAC/Hz)	Input Voltage (VDC)	Max Output wattage (W)	Output Voltage (V)	Output Current max (A)	Maximum capacitive load (μF)	Efficiency @ 230VAC (%)
AME25-3S277LPZ	85-305/47-63	100-430	13.5	3.3	4.1	48000	78
AME25-5S277LPZ	85-305/47-63	100-430	20.5	5	4.1	12240	82
AME25-9S277LPZ	85-305/47-63	100-430	22.5	9	2.5	5600	82
AME25-12S277LPZ	85-305/47-63	100-430	25.2	12	2.1	5400	84
AME25-15S277LPZ	85-305/47-63	100-430	24	15	1.6	2400	85
AME25-24S277LPZ	85-305/47-63	100-430	26.4	24	1.1	1440	85
AME25-48S277LPZ	85-305/47-63	100-430	24	48	0.5	600	87

### Input Specifications

Parameters	Conditions	Minimum	Typical	Maximum	Units
Input current	115VAC			0.6	A
	230VAC			0.34	A
Inrush current	115VAC		20		A
	230VAC		40		A
Leakage current	277VAC/50Hz			0.25	mA (RMS)
Fuse	3.15A/300V, Slow blow, built-in				

### Output Specifications

Parameters	Conditions	Typical	Maximum	Units
Voltage accuracy	3.3V output	±3		%
	Others	±2		%
Line regulation	Full load	±0.5		%
Load regulation	0-100% load	±1		%
Ripple & Noise*	20MHz bandwidth	50	100	mV <sub>p-p</sub>
Hold up time	115VAC	10		ms
	230VAC	60		ms

\* Ripple and Noise are measured at 20MHz bandwidth by using the referenced Application circuit.

### Isolation Specifications

Parameters	Conditions	Typical	Rated	Units
Tested I/O voltage	60 sec		4200	VAC
Insulation resistance	500VDC		≥ 100	MΩ

General Specifications				
Parameters	Conditions	Typical	Maximum	Units
Switching frequency		65		KHz
Overvoltage category	OVC III			
Over Current protection	Auto recovery	≥ 110		% of I <sub>out</sub>
Over voltage protection	3.3V / 5V Vout		7.5	VDC
	9V Vout		15	VDC
	12V /15V Vout		20	VDC
	24V Vout		30	VDC
	48V Vout		60	VDC
Short circuit protection	Hiccup, Continuous, Auto recovery			
Operating temperature	See derating graph	-40 to +85		°C
Storage temperature		-40 to +105		°C
Lead temperature	Wave soldering	260 ± 5 °C; time : 5 - 10s		
	Hand soldering	360 ± 10 °C; time : 3 - 5s		
Power consumption	230VAC, Others		0.3	W
	230VAC, 48V Vout		0.4	W
Power derating	-40 °C ~ -25 °C	3.33		% / °C
	50 °C ~ 70 °C	2.5		% / °C
	70 °C ~ 85 °C	0.67		% / °C
	85VAC ~ 100VAC	1		% / VAC
	277VAC ~ 305VAC	0.715		% / VAC
	2000m – 5000m	6.67		% / Km
Temperature coefficient		±0.02		% / °C
Cooling	Free air convection			
Humidity	Non-condensing		95	% RH
Case material	Heat resistant black Plastic (flammability to UL 94V-0)			
Weight		120		g
Dimensions (L x W x H)	2.76 x 1.89 x 0.93 inches (70.0 x 48.0 x 23.5mm)			
MTBF	> 1 000 000 hrs (MIL-HDBK -217F, t <sub>a</sub> =+25°C)/Full Load			
NOTE: All specifications in this datasheet are measured at an ambient temperature of 25°C, humidity<75%, nominal input voltage and at rated output load unless otherwise specified.				

Safety Specifications		
Parameters		
Standards	Information technology Equipment	Designed to meet IEC/EN/UL 62368, IEC/EN 60335, IEC/EN 61558-1
	EMC - Conducted and radiated emission	CISPR32 / EN55032, CLASS B
	Electrostatic Discharge Immunity	IEC 61000-4-2 Contact ±8KV / Air ±15KV, Criteria B
	RF, Electromagnetic Field Immunity	IEC 61000-4-3 10V/m, Criteria A
	Electrical Fast Transient/Burst Immunity	IEC 61000-4-4 ±4KV, Criteria B
	Surge Immunity	IEC 61000-4-5 L-L ±2KV, Criteria B
	CS, Conducted Disturbance Immunity	IEC 61000-4-6 10Vr.m.s, Criteria A
Voltage dips, Short Interruptions Immunity	IEC 61000-4-11 0%, 70%, Criteria B	

Derating

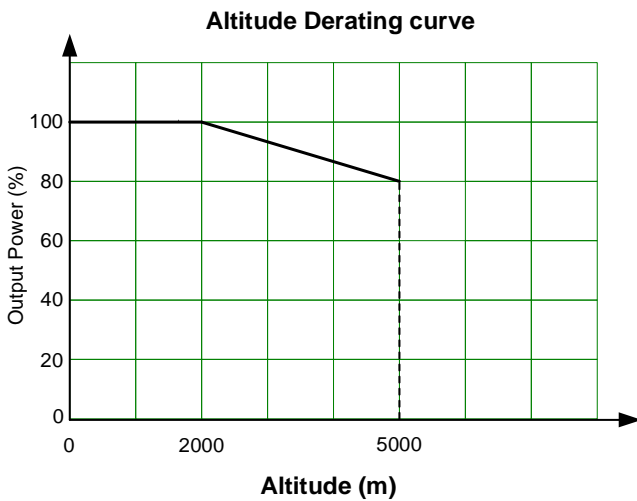
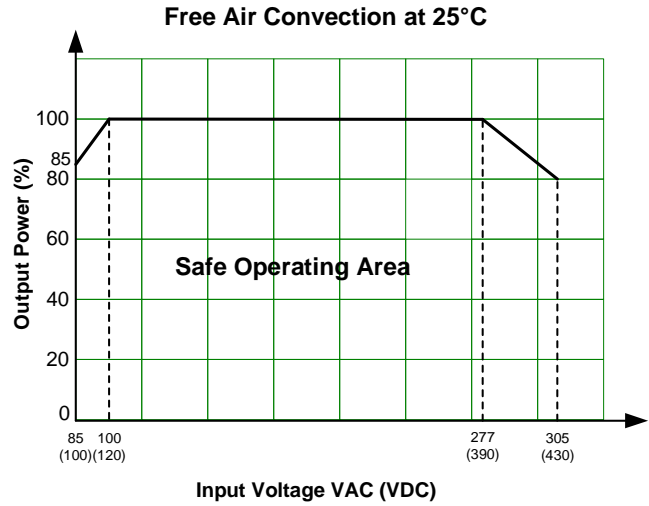
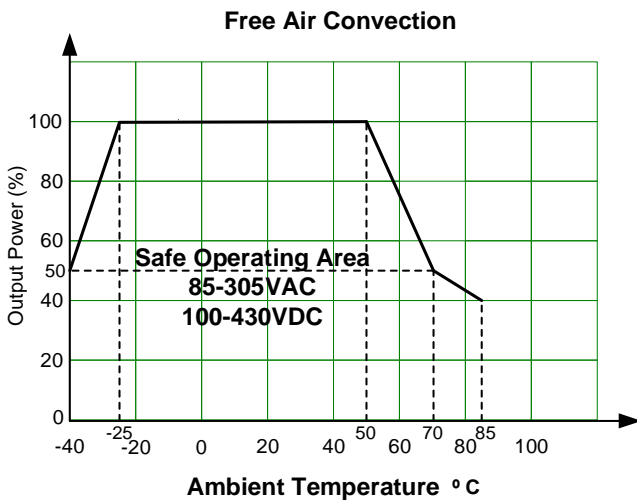

Typical Application Circuit



Single Output

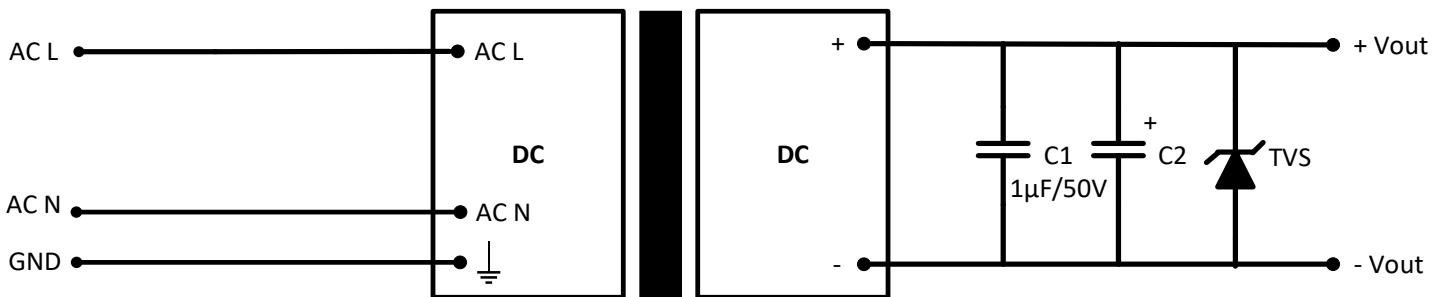

Model	C2	TVS
3.3 / 5V Vout	330 $\mu$ F / 16V	SMBJ7.0A
9 Vout	330 $\mu$ F / 16V	SMBJ12A
12 / 15 Vout	330 $\mu$ F / 25V	SMBJ20A
24 Vout	330 $\mu$ F / 35V	SMBJ30A
48 Vout	330 $\mu$ F / 63V	SMBJ64A

**Output Filter Components:**

We recommend using an electrolytic capacitor with high frequency, and low ESR rating for C2. C1 is a ceramic capacitor used for filtering high-frequency noise and TVS is a recommended suppressor diode.

**Dimensions**

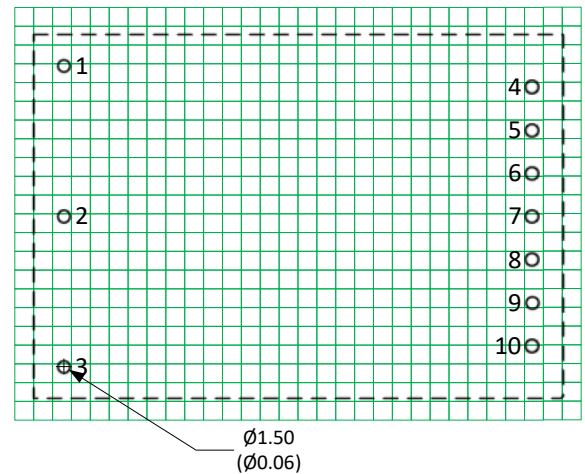
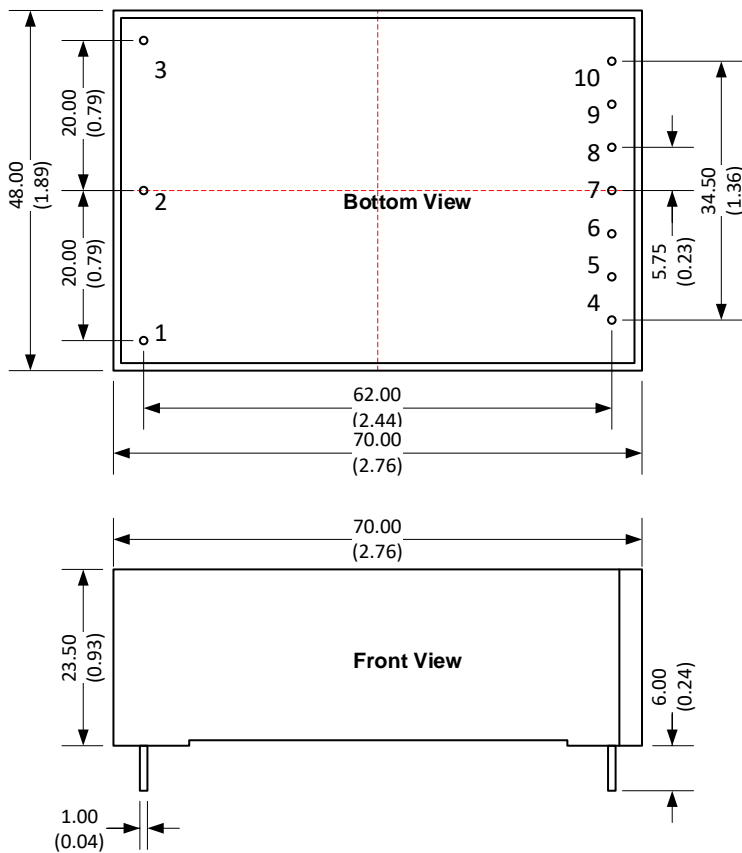

**Notes:**

All dimensions are typical in millimeters (inches).  
 Pin diameter tolerances :  $\pm 0.15$  ( $\pm 0.006$ )  
 General tolerance :  $\pm 1.00$  ( $\pm 0.04$ )

Pin Output Specifications			
Pin	Single	Pin	Single
1	Ground	6	No pin
2	AC Input (N)	7	No pin
3	AC Input (L)	8	No pin
4	Trim	9	+V Output
5	-V Output	10	No pin

## Trimming



Output voltage can be externally trimmed by utilizing the methods as shown below

### Fixed Resistor

### Variable Potentiometer

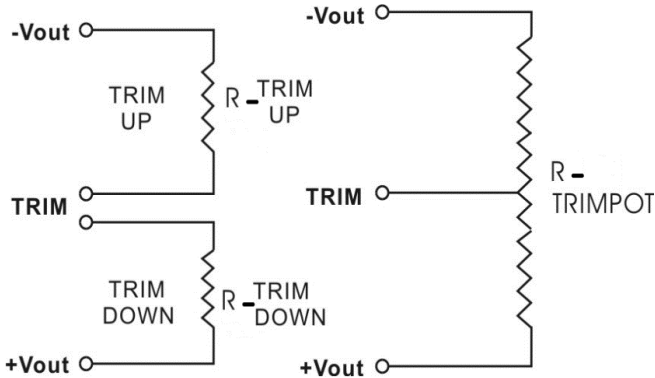

Leave open if not used.

## AME25-3S277LPZ

Trim down %	1	2	3	4	5	6	7	8	9	10
Vout (VDC)	3.267	3.234	3.201	3.168	3.135	3.102	3.069	3.036	3.003	2.970
Rt down (KΩ)	240.741	154.964	113.111	88.321	71.927	60.280	51.580	44.834	39.450	35.053
Trim up %	1	2	3	4	5	6	7	8	9	10
Vout (VDC)	3.333	3.366	3.399	3.432	3.465	3.498	3.531	3.564	3.597	3.630
Rt up (KΩ)	2987.087	256.530	133.563	90.076	67.832	54.320	45.243	38.725	33.817	29.988

## AME25-5S277LPZ

Trim down %	1	2	3	4	5	6	7	8	9	10
Vout (VDC)	4.950	4.900	4.850	4.800	4.750	4.700	4.650	4.600	4.550	4.500
Rt down (KΩ)	169.169	112.938	83.743	65.865	53.792	45.092	38.524	33.390	29.267	25.883
Trim up %	1	2	3	4	5	6	7	8	9	10
Vout (VDC)	5.060	5.100	5.150	5.200	5.250	5.300	5.350	5.400	5.450	5.500
Rt up (KΩ)	--	445.226	202.762	131.024	96.647	76.473	63.208	53.821	46.829	41.419

## AME25-9S277LPZ

Trim down %	1	2	3	4	5	6	7	8	9	10
Vout (VDC)	8.910	8.820	8.730	8.640	8.550	8.460	8.370	8.280	8.190	8.100
Rt down (KΩ)	682.347	378.845	259.708	196.082	156.501	129.500	109.904	95.034	83.365	73.964
Trim up %	1	2	3	4	5	6	7	8	9	10
Vout (VDC)	9.090	9.180	9.270	9.360	9.450	9.540	9.630	9.720	9.810	9.900
Rt up (KΩ)	485.777	200.712	126.214	91.902	72.168	59.348	50.351	43.689	38.557	34.482

### AME25-12S277LPZ

Trim down %	1	2	3	4	5	6	7	8	9	10
Vout (VDC)	11.880	11.760	11.640	11.520	11.400	11.280	11.160	11.040	10.920	10.800
Rt down (KΩ)	1291.752	754.558	528.676	404.287	325.536	271.199	231.447	201.102	177.179	157.834
Trim up %	1	2	3	4	5	6	7	8	9	10
Vout (VDC)	12.120	12.240	12.360	12.480	12.600	12.720	12.840	12.960	13.080	13.200
Rt up (KΩ)	910.025	321.824	195.168	139.891	108.918	89.109	75.349	65.235	57.488	51.362

### AME25-15S277LPZ

Trim down %	1	2	3	4	5	6	7	8	9	10
Vout (VDC)	14.850	14.700	14.550	14.400	14.250	14.100	13.950	13.800	13.650	13.500
Rt down (KΩ)	893.077	571.417	417.212	326.705	267.184	225.063	193.684	169.404	150.057	134.280
Trim up %	1	2	3	4	5	6	7	8	9	10
Vout (VDC)	15.150	15.300	15.450	15.600	15.750	15.900	16.050	16.200	16.350	16.500
Rt up (KΩ)	2105.383	286.791	153.446	104.544	79.162	63.621	53.128	45.566	39.858	35.397

### AME25-24S277LPZ

Trim down %	1	2	3	4	5	6	7	8	9	10
Vout (VDC)	23.760	23.520	23.280	23.040	22.800	22.560	22.320	22.080	21.840	21.600
Rt down (KΩ)	1063.929	700.514	518.971	410.098	337.538	285.720	246.862	216.643	192.470	172.694
Trim up %	1	2	3	4	5	6	7	8	9	10
Vout (VDC)	24.240	24.480	24.720	24.960	25.200	25.440	25.680	25.920	26.160	26.400
Rt up (KΩ)	68999.000	248.097	123.774	82.233	61.443	48.964	40.642	34.696	30.236	26.767

### AME25-48S277LPZ

Trim down %	1	2	3	4	5	6	7	8	9	10
Vout (VDC)	47.520	47.040	46.560	46.080	45.600	45.120	44.640	44.160	43.680	43.200
Rt down (KΩ)	1352.055	871.467	639.143	502.197	411.899	347.882	300.130	263.143	233.650	209.583
Trim up %	1	2	3	4	5	6	7	8	9	10
Vout (VDC)	48.480	48.960	49.440	49.920	50.400	50.880	51.360	51.840	52.320	52.800
Rt up (KΩ)	1094.199	123.623	65.071	43.951	33.063	26.421	21.946	18.727	16.300	14.405

**NOTE:** **1.** Datasheets are updated as needed and as such, specifications are subject to change without notice. Once printed or downloaded, datasheets are no longer controlled by Aimtec; refer to [www.aimtec.com](http://www.aimtec.com) for the most current product specifications. **2.** Product labels shown, including safety agency certifications on labels, may vary based on the date manufactured. **3.** Mechanical drawings and specifications are for reference only. **4.** All specifications are measured at an ambient temperature of 25°C, humidity<75%, nominal input voltage and at rated output load unless otherwise specified. **5.** Aimtec may not have conducted destructive testing or chemical analysis on all internal components and chemicals at the time of publishing this document. CAS numbers and other limited information are considered proprietary and may not be available for release. **6.** This product is not designed for use in critical life support systems, equipment used in hazardous environments, nuclear control systems or other such applications which necessitate specific safety and regulatory standards other than the ones listed in this datasheet. **7.** Warranty is in accordance with Aimtec's standard Terms of Sale available at [www.aimtec.com](http://www.aimtec.com).