

Click to
ORDER
samples

AM2M-JZ

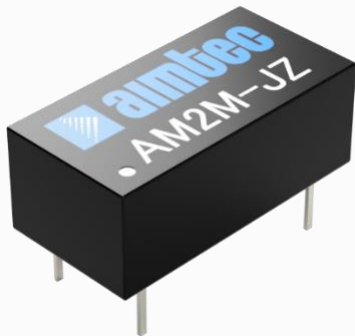

DIP14 Package

The AM2M-JZ is a 2W DIP14 DC/DC converter that offers great cost savings thanks to an improved manufacturing process. It also features excellent reliability and performance while offering a standard input voltage range of 3.3-24VDC as well as an output voltage of 3.3-15V. This compact DIP14 design will surely benefit your new system design.

This new series offers great operating temperatures, from -40 to 105°C with full power up to 85°C. Also, an isolation of 1500 and 3000VDC for improved reliability and system safety as well as a great 3,500,000h MTBF come standard.

The AM2M-JZ is suitable for instrumentation, industrial controls, industrial applications, communication and IoT applications.

Features

- High I/O Isolation of 1500/3000VDC
- Continuous Short circuit protection
- Operating Temp: -40 °C to +105 °C
- Industry standard DIP14 pin-out
- Efficiency up to 86%
- Unregulated output



Summary

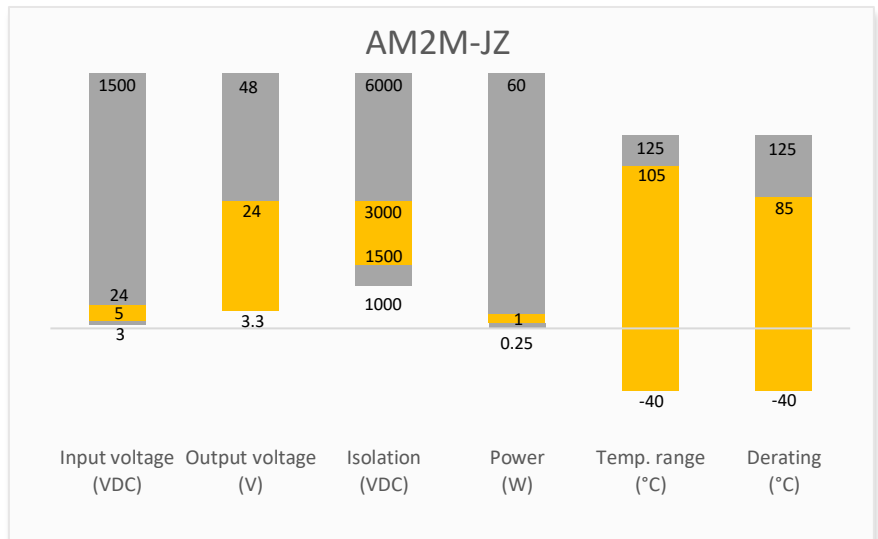

Training



Product Training Video
(click to open)



Press Release

Coming Soon!

Application Notes

Applications



IoT



Industrial



Telecom



Portable Equipment

Models & Specifications

Single Output							
Model	Input Voltage (VDC)	Output Voltage (VDC)	Input Current Full No load typ. (mA)	Output Current max min (mA)*	Isolation (VDC)	Maximum capacitive Load (μF)	Efficiency Typ. (%)
AM2M-0303SJZ	3.3 (2.97-3.63)	3.3	513 / 12	400 / 40	1500	2400	78
AM2M-0305SJZ	3.3 (2.97-3.63)	5	778 / 12	400 / 40	1500	2400	78
AM2M-0503SJZ	5 (4.5-5.5)	3.3	513 / 8	400 / 40	1500	2400	78
AM2M-0505SJZ	5 (4.5-5.5)	5	477 / 8	400 / 40	1500	2400	84
AM2M-0509SJZ	5 (4.5-5.5)	9	471 / 8	222 / 22	1500	1000	85
AM2M-0512SJZ	5 (4.5-5.5)	12	471 / 8	167 / 17	1500	560	85
AM2M-0515SJZ	5 (4.5-5.5)	15	466 / 8	133 / 13	1500	560	86
AM2M-0524SJZ	5 (4.5-5.5)	24	466 / 8	83 / 8	1500	220	86
AM2M-0503SH30JZ	5 (4.5-5.5)	3.3	513 / 8	400 / 40	3000	2400	78
AM2M-0505SH30JZ	5 (4.5-5.5)	5	477 / 8	400 / 40	3000	2400	84
AM2M-0509SH30JZ	5 (4.5-5.5)	9	471 / 8	222 / 22	3000	1000	85
AM2M-0512SH30JZ	5 (4.5-5.5)	12	471 / 8	167 / 17	3000	560	85
AM2M-0515SH30JZ	5 (4.5-5.5)	15	466 / 8	133 / 13	3000	560	86
AM2M-0524SH30JZ	5 (4.5-5.5)	24	466 / 8	83 / 8	3000	220	86
AM2M-1205SH30JZ	12 (10.8-13.2)	5	208 / 8	400 / 40	3000	2400	82
AM2M-1209SH30JZ	12 (10.8-13.2)	9	208 / 8	222 / 23	3000	1200	82
AM2M-1212SH30JZ	12 (10.8-13.2)	12	208 / 8	167 / 17	3000	560	84
AM2M-1215SH30JZ	12 (10.8-13.2)	15	208 / 8	133 / 13	3000	560	85
AM2M-1224SH30JZ	12 (10.8-13.2)	24	208 / 8	83 / 8	3000	220	86
AM2M-1505SH30JZ	15 (13.5-16.5)	5	169 / 8	400 / 40	3000	2400	79
AM2M-1509SH30JZ	15 (13.5-16.5)	9	169 / 8	222 / 23	3000	1200	82
AM2M-1515SH30JZ	15 (13.5-16.5)	15	169 / 8	133 / 13	3000	560	79
AM2M-2405SH30JZ	24 (21.6-26.4)	5	104 / 8	400 / 40	3000	2400	80
AM2M-2409SH30JZ	24 (21.6-26.4)	9	104 / 8	222 / 23	3000	1200	80
AM2M-2412SH30JZ	24 (21.6-26.4)	12	104 / 8	167 / 17	3000	560	84
AM2M-2415SH30JZ	24 (21.6-26.4)	15	104 / 8	133 / 13	3000	560	86
AM2M-2424SH30JZ	24 (21.6-26.4)	24	104 / 8	83 / 8	3000	220	86

* Performance will be degraded if the load is not within the output current range.

Dual Output							
Model	Input Voltage (VDC)	Output Voltage (VDC)	Input Current Full No load typ. (mA)	Output Current max min (mA)*	Isolation (VDC)	Maximum capacitive Load (μF)	Efficiency Typ. (%)
AM2M-0503DJZ	5 (4.5-5.5)	±3.3	513 / 8	±303 / ±30	1500	±1200	78
AM2M-0505DJZ	5 (4.5-5.5)	±5	477 / 8	±200 / ±20	1500	±1200	84
AM2M-0507DJZ	5 (4.5-5.5)	±7	477 / 8	±143 / ±14	1500	±470	84
AM2M-0509DJZ	5 (4.5-5.5)	±9	471 / 8	±111 / ±11	1500	±470	85
AM2M-0512DJZ	5 (4.5-5.5)	±12	471 / 8	±83 / ±8	1500	±220	85
AM2M-0515DJZ	5 (4.5-5.5)	±15	466 / 8	±67 / ±7	1500	±220	86
AM2M-0524DJZ	5 (4.5-5.5)	±24	466 / 8	±42 / ±4	1500	±100	86
AM2M-0503DH30JZ	5 (4.5-5.5)	±3.3	513 / 8	±303 / ±30	3000	±1200	78

AM2M-0505DH30JZ	5 (4.5-5.5)	±5	477 / 8	±200 / ±20	3000	±1200	84
AM2M-0509DH30JZ	5 (4.5-5.5)	±9	471 / 8	±111 / ±11	3000	±470	85
AM2M-0512DH30JZ	5 (4.5-5.5)	±12	471 / 8	±83 / ±8	3000	±220	85
AM2M-0515DH30JZ	5 (4.5-5.5)	±15	466 / 8	±67 / ±7	3000	±220	86
AM2M-0524DH30JZ	5 (4.5-5.5)	±24	466 / 8	±42 / ±4	3000	±100	86
AM2M-1203DH30JZ	12 (10.8-13.2)	±3.3	208 / 8	±303 / ±30	3000	±1200	75
AM2M-1205DH30JZ	12 (10.8-13.2)	±5	208 / 8	±200 / ±20	3000	±1200	80
AM2M-1212DH30JZ	12 (10.8-13.2)	±12	208 / 8	±83 / ±8	3000	±220	83
AM2M-1215DH30JZ	12 (10.8-13.2)	±15	208 / 8	±67 / ±7	3000	±220	83
AM2M-1224DH30JZ	12 (10.8-13.2)	±24	208 / 8	±42 / ±4	3000	±100	85
AM2M-1509DH30JZ	15 (13.5-16.5)	±9	169 / 8	±111 / ±11	3000	±560	81
AM2M-1512DH30JZ	15 (13.5-16.5)	±12	169 / 8	±83 / ±8	3000	±220	81
AM2M-1515DH30JZ	15 (13.5-16.5)	±15	169 / 8	±67 / ±7	3000	±220	81
AM2M-2405DH30JZ	24 (21.6-26.4)	±5	104 / 8	±200 / ±20	3000	±1200	80
AM2M-2412DH30JZ	24 (21.6-26.4)	±12	104 / 8	±83 / ±8	3000	±220	83
AM2M-2415DH30JZ	24 (21.6-26.4)	±15	104 / 8	±67 / ±7	3000	±220	83
AM2M-2424DH30JZ	24 (21.6-26.4)	±24	104 / 8	±42 / ±4	3000	±100	84

* Performance will be degraded if the load is not within the output current range.

Input Specification

Parameters	Conditions	Typical	Maximum	Units
Filter	Capacitor			
Absolute maximum rating	Maximum duration 1s, 3.3Vin	> -0.7	5	VDC
	Maximum duration 1s, 5Vin	> -0.7	9	VDC
	Maximum duration 1s, 12Vin	> -0.7	18	VDC
	Maximum duration 1s, 15Vin	> -0.7	21	VDC
	Maximum duration 1s, 24Vin	> -0.7	30	VDC
Input reflected ripple current	3.3V input models	30		mA
	Others	15		mA

Isolation Specification

Parameters	Conditions	Typical	Maximum	Units
Tested I/O voltage	H30 models, 60 sec, leakage ≤ 1mA	>3000		VDC
	Other models, 60 sec, leakage ≤ 1mA	>1500		VDC
Resistance	500VDC	>1000		MΩ
Capacitance	100kHz/0.1V	20		pF

Output Specification

Parameters	Conditions	Typical	Maximum	Units
Voltage accuracy	See output voltage tolerance	10	16	%
Line regulation	Per 1% Vin change, 3.3Vout models		±1.5	%
	Per 1% Vin change, other models		±1.2	%
Load regulation	10-100% load, AM2M-0305SJZ model		25	%
	10-100% load, 3.3Vout models		20	%
	10-100% load, 5/7Vout models		15	%
	10-100% load, other models		10	%
Ripple & Noise*	3.3Vin, 5Vin models and 24Vout models	75	200	mV pk-pk
	Other models	75	180	mV pk-pk

Temperature coefficient		±0.02		%/°C
* Ripple and Noise are measured at 20MHz bandwidth. Please refer to the application note for specific details.				

General Specifications				
Parameters	Conditions	Typical	Maximum	Units
Switching frequency	Full load, nominal input, 3.3V/5Vin models	220		KHz
	Full load, nominal input, other models	260		KHz
Short circuit protection	Continuous, Auto recovery			
Operating temperature	With derating	-40 to +105		°C
Storage temperature		-55 to +125		°C
Case temperature rise	Ambient temperature at 25°C	25		°C
Manual soldering temperature	1.5mm away from case, duration ≤ 10sec		300	°C
Cooling	Free air convection			
Humidity	Non-condensing	>5	95	% RH
Vibration	10-150Hz, 5G, 0.75mm, along all axis			
Case material	Black plastic (flammability to UL 94V-0)			
Weight		2.4		g
Dimensions (L x W x H)	0.8 x 0.4 x 0.32 inches (20.32 x 10.16 x 8.20 mm)			
MTBF	3 500 000 hrs (MIL-HDBK -217F, t=+25°C) / Full Load			
NOTE: All specifications in this datasheet are measured at an ambient temperature of 25°C, humidity<75%, nominal input voltage and at rated output load unless otherwise specified.				

Safety Specifications		
Parameters		
Standards	Information technology Equipment	Design to meet IEC/EN/UL62368
	EMC - Conducted and radiated emission	CISPR32 / EN55032, class B with the recommended EMI circuit
	Electrostatic Discharge Immunity	IEC 61000-4-2 Air ±8KV, Contact ±6KV, Criteria B

Derating

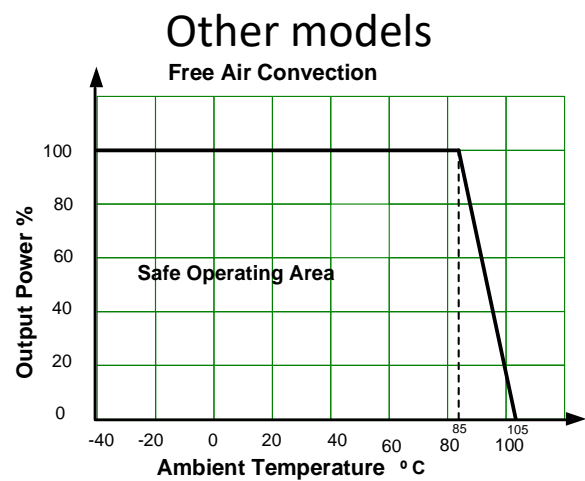
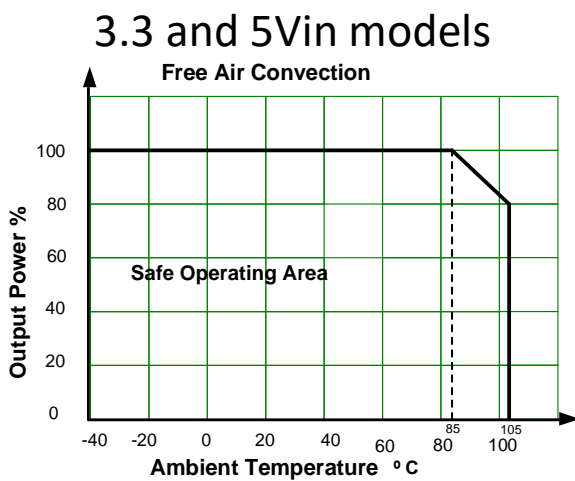

Output voltage tolerance

12/15/24Vin, 3.3Vout models

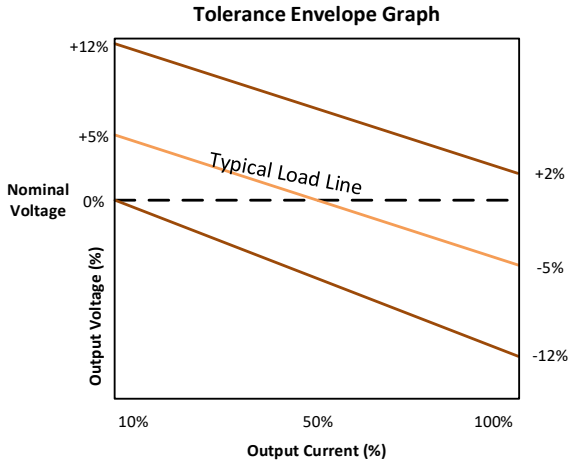

12/15/24Vin, 5Vout models

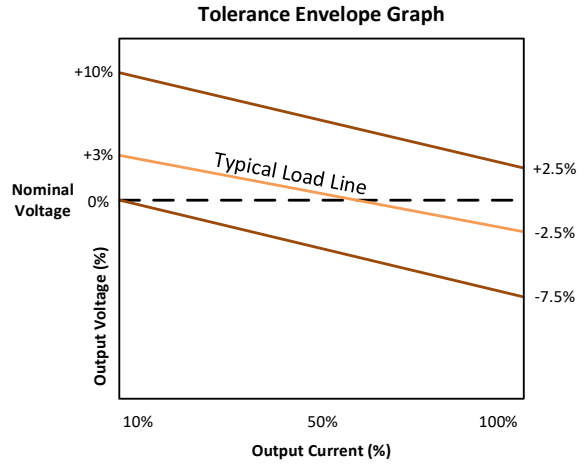

12/15/24Vin, Other models

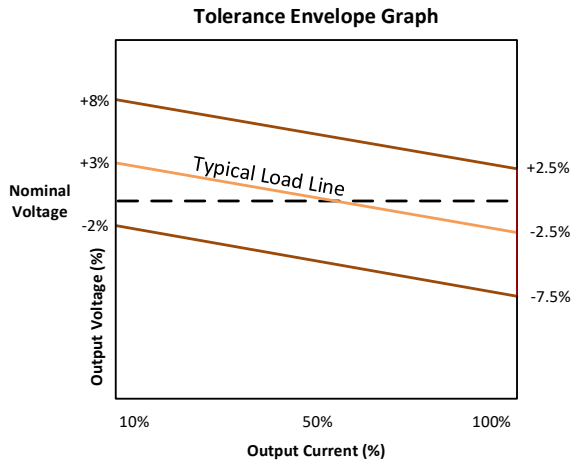

3.3/5Vin, 3.3Vout models

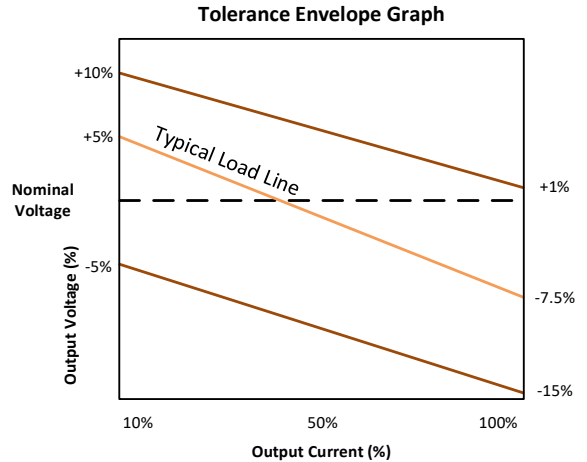

5Vin, Other models

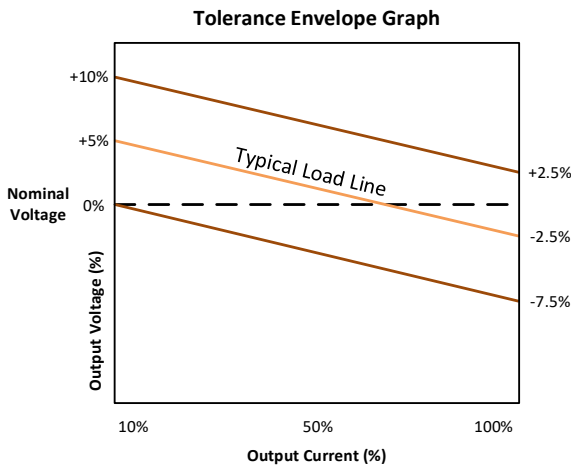

3.3Vin, 5Vout model

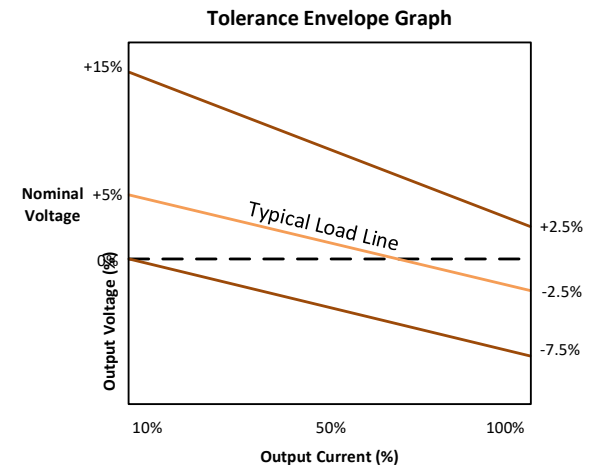

Typical application circuit

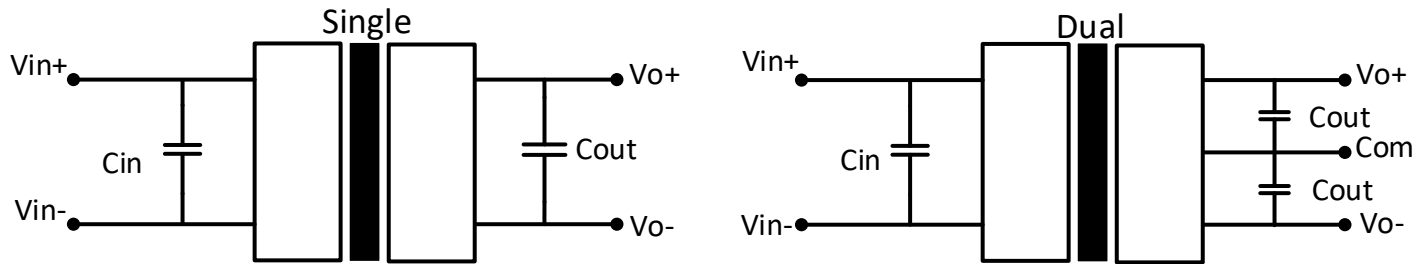

Vin	Cin	Single output models		Dual output models	
		Vout	Cout	Vout	Cout
5	4.7μF/16V	3.3V	10μF/16V	±3.3V	4.7μF/16V
12	2.2μF/25V	5V	10μF/16V	±5V	4.7μF/16V
15	2.2μF/25V	9V	2.2μF/25V	±7V	4.7μF/16V
24	1μF/50V	12V	2.2μF/25V	±9V	1μF/25V
-	-	15V	2.2μF/25V	±12V	1μF/25V
-	-	24V	1μF/50V	±15V	1μF/25V
-	-	-	-	±24V	0.47μF/50V

Recommended EMI circuit

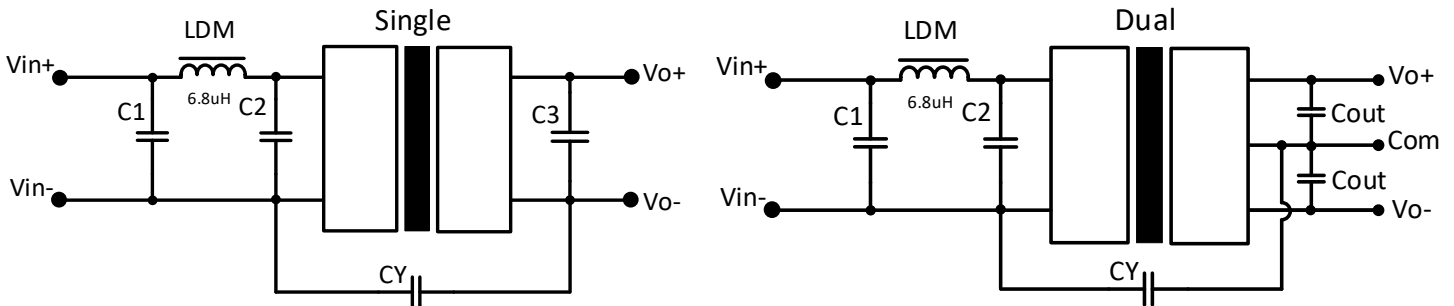

Vin	C1/C2	Vout	CY		C3
			1500VDC isolation	3000VDC isolation	
3.3V/5V	4.7μF/16V	All output	270pF/2kVdc	270pF/4kVdc	Refer to Cout in typical circuit
12V/15V/24V	4.7μF/50V	All output	-	270pF/3kVdc	Refer to Cout in typical circuit

Dimensions

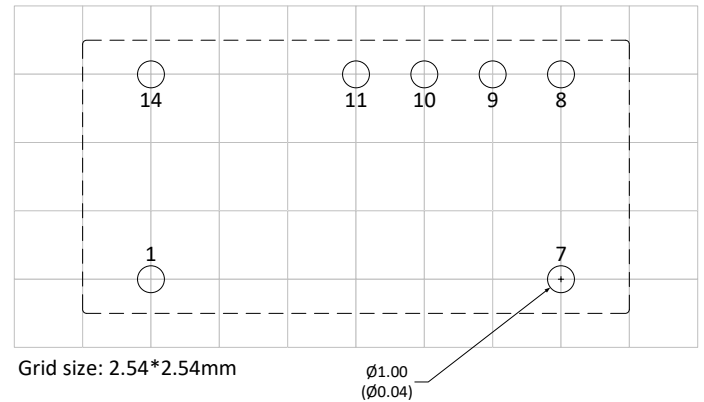
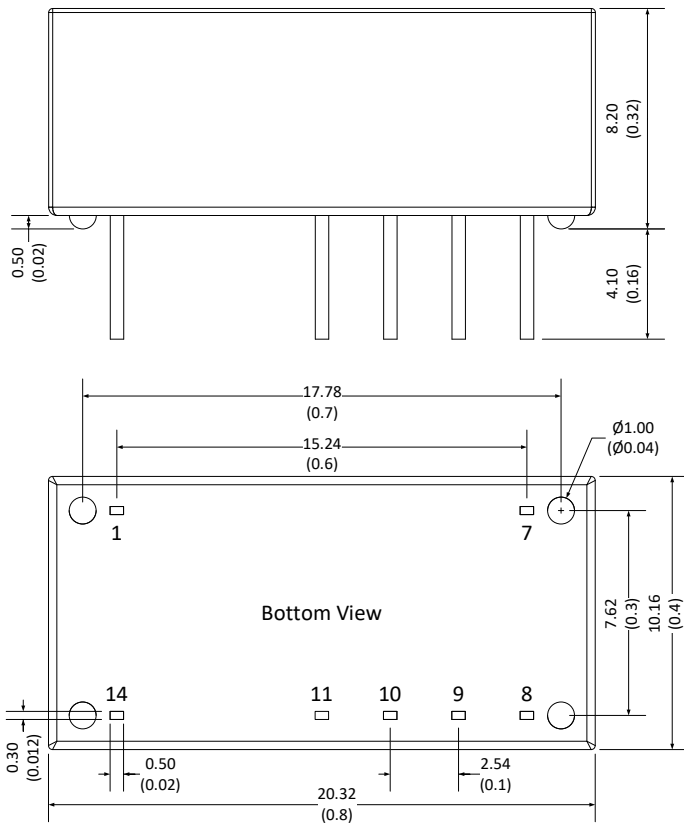

Note:
Unit: mm(inch)
General tolerance: ± 0.25 (0.01)
Pin tolerance: ± 0.1 (0.004)

Pin	Pin Out Specifications			
	1.5KV isolation models		3KV isolation models	
	Single output	Dual output	Single output	Dual output
1	-V Input	-V Input	-V Input	-V Input
7	NC	NC	NC	NC
8	-V Output	Com	+V Output	+V Output
9	+V Output	+V Output	No pin	Com
10	No pin	No pin	-V Output	-V Output
11	No pin	-V Output	No pin	No pin
14	+V Input	+V Input	+V Input	+V Input

NOTE: 1. Datasheets are updated as needed and as such, specifications are subject to change without notice. Once printed or downloaded, datasheets are no longer controlled by Aimtec; refer to www.aimtec.com for the most current product specifications. 2. Product labels shown, including safety agency certifications on labels, may vary based on the date manufactured. 3. Mechanical drawings and specifications are for reference only. 4. All specifications are measured at an ambient temperature of 25°C, humidity<75%, nominal input voltage and at rated output load unless otherwise specified. 5. Aimtec may not have conducted destructive testing or chemical analysis on all internal components and chemicals at the time of publishing this document. CAS numbers and other limited information are considered proprietary and may not be available for release. 6. This product is not designed for use in critical life support systems, equipment used in hazardous environments, nuclear control systems or other such applications which necessitate specific safety and regulatory standards other the ones listed in this datasheet. 7. Warranty is in accordance with Aimtec's standard Terms of Sale available at www.aimtec.com.