

Click to
ORDER
samples

AM2LS-JZ

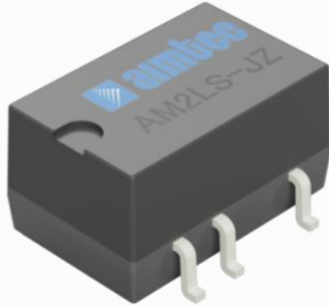

SMD Package

The AM2LS-JZ is a 2W SMD DC/DC converter that offers great cost savings thanks to an improved manufacturing process. It also features excellent reliability and performance while offering a standard input voltage range of 5, 12, 15, 24VDC as well as an output voltage of 3.3-24V. This compact SMD design will surely benefit your new system design.

This new series offers great operating temperatures, from -40 to 105°C with full power up to 71 or 85°C. Also, an isolation of 1500VDC & 3000VDC for improved reliability and system safety as well as a great 3,500,000h MTBF come standard.

The AM2LS-JZ is suitable for instrumentation, industrial controls, industrial applications, communication interface and IoT applications.

Features

- High I/O Isolation 1500VDC & 3000VDC
- Continuous Short circuit protection
- Operating Temp: -40 °C to +105 °C
- Low profile case height: 7.25mm
- Compact footprint and high-power Density
- Efficiency up to 86%
- Unregulated output

Summary

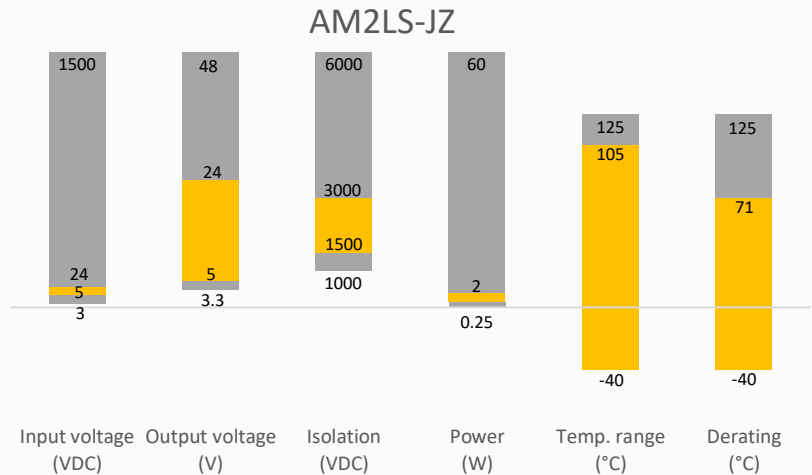

Training



Product Training Video
(click to open)



Press Release

Coming Soon!

Application Notes

Applications



IoT



Industrial



Telecom



Portable Equipment

Models & Specifications



Single Output

Model	Input Voltage (VDC)	Output Voltage (VDC)	Input Current Full No load typ. (mA)	Output Current max min (mA)	Isolation (VDC)	Maximum capacitive Load (μF)	Efficiency Typ. (%)
AM2LS-0503SJZ	5 (4.5-5.5)	3.3	339 / 8	400 / 40	1500	2400	78
AM2LS-0505SJZ	5 (4.5-5.5)	5	477 / 8	400 / 40	1500	2400	84
AM2LS-0507SJZ	5 (4.5-5.5)	7	477 / 8	286 / 29	1500	1000	84
AM2LS-0509SJZ	5 (4.5-5.5)	9	471 / 8	222 / 22	1500	1000	85
AM2LS-0512SJZ	5 (4.5-5.5)	12	471 / 8	167 / 17	1500	560	85
AM2LS-0515SJZ	5 (4.5-5.5)	15	466 / 8	133 / 13	1500	560	86
AM2LS-0524SJZ	5 (4.5-5.5)	24	466 / 8	83 / 8	1500	220	86
AM2LS-1205SJZ	12 (10.8-13.2)	5	196 / 8	400 / 40	1500	2400	83
AM2LS-1209SJZ	12 (10.8-13.2)	9	196 / 8	222 / 22	1500	1000	83
AM2LS-1212SJZ	12 (10.8-13.2)	12	196 / 8	167 / 17	1500	560	84
AM2LS-1215SJZ	12 (10.8-13.2)	15	196 / 8	133 / 13	1500	560	84
AM2LS-1224SJZ	12 (10.8-13.2)	24	196 / 8	83 / 8	1500	220	85
AM2LS-1505SJZ	15 (13.5-16.5)	5	161 / 8	400 / 40	1500	2400	83
AM2LS-1515SJZ	15 (13.5-16.5)	15	161 / 8	133 / 13	1500	560	84
AM2LS-2405SJZ	24 (21.6-26.4)	5	98 / 8	400 / 40	1500	2400	83
AM2LS-2409SJZ	24 (21.6-26.4)	9	98 / 8	222 / 22	1500	1000	83
AM2LS-2412SJZ	24 (21.6-26.4)	12	98 / 8	167 / 17	1500	560	84
AM2LS-2415SJZ	24 (21.6-26.4)	15	98 / 8	133 / 13	1500	560	84
AM2LS-2424SJZ	24 (21.6-26.4)	24	98 / 8	83 / 8	1500	220	85
AM2LS-0503SH30JZ	5 (4.5-5.5)	3.3	339 / 8	400 / 40	3000	2400	78
AM2LS-0505SH30JZ	5 (4.5-5.5)	5	477 / 8	400 / 40	3000	2400	84
AM2LS-0507SH30JZ	5 (4.5-5.5)	7	477 / 8	286 / 29	3000	1000	84
AM2LS-0509SH30JZ	5 (4.5-5.5)	9	471 / 8	222 / 22	3000	1000	85
AM2LS-0512SH30JZ	5 (4.5-5.5)	12	471 / 8	167 / 17	3000	560	85
AM2LS-0515SH30JZ	5 (4.5-5.5)	15	466 / 8	133 / 13	3000	560	86
AM2LS-0524SH30JZ	5 (4.5-5.5)	24	466 / 8	83 / 8	3000	220	86
AM2LS-1205SH30JZ	12 (10.8-13.2)	5	196 / 8	400 / 40	3000	2400	83
AM2LS-1206SH30JZ	12 (10.8-13.2)	6	196 / 8	333 / 33	3000	1000	83
AM2LS-1209SH30JZ	12 (10.8-13.2)	9	196 / 8	222 / 22	3000	1000	83
AM2LS-1212SH30JZ	12 (10.8-13.2)	12	196 / 8	167 / 17	3000	560	84
AM2LS-1215SH30JZ	12 (10.8-13.2)	15	196 / 8	133 / 13	3000	560	84
AM2LS-1224SH30JZ	12 (10.8-13.2)	24	196 / 8	83 / 8	3000	220	85
AM2LS-1505SH30JZ	15 (13.5-16.5)	5	161 / 8	400 / 40	3000	2400	83
AM2LS-1515SH30JZ	15 (13.5-16.5)	15	161 / 8	133 / 13	3000	560	84
AM2LS-2405SH30JZ	24 (21.6-26.4)	5	98 / 8	400 / 40	3000	2400	83
AM2LS-2409SH30JZ	24 (21.6-26.4)	9	98 / 8	222 / 22	3000	1000	83
AM2LS-2412SH30JZ	24 (21.6-26.4)	12	98 / 8	167 / 17	3000	560	84
AM2LS-2415SH30JZ	24 (21.6-26.4)	15	98 / 8	133 / 13	3000	560	84
AM2LS-2424SH30JZ	24 (21.6-26.4)	24	98 / 8	83 / 8	3000	220	85

Note: Use suffix "TR" for tape & reel packing (ex. AM2LS-1205SJZTR).

Input Specification				
Parameters	Conditions	Typical	Maximum	Units
Filter	Capacitor			
Absolute maximum rating	Maximum duration 1s, 5Vin	> -0.7	9	VDC
	Maximum duration 1s, 12Vin	> -0.7	18	VDC
	Maximum duration 1s, 24Vin	> -0.7	30	VDC
Input reflected ripple current	5Vin	15		mA
	Others	30		mA

Isolation Specification				
Parameters	Conditions	Typical	Maximum	Units
Tested I/O voltage	60 sec, leakage \leq 1mA	>1500		VDC
	60 sec, leakage \leq 1mA for H30 models	>3000		VDC
Resistance	500VDC	>1000		M Ω
Capacitance	100kHz/0.1V	20		pF

Output Specification				
Parameters	Conditions	Typical	Maximum	Units
Voltage accuracy	See output voltage tolerance	10	16	%
Line regulation	Per 1% Vin change, 3.3Vout		1.5	%
	Per 1% Vin change, others		1.2	%
Load regulation	10-100% load, 3.3Vout (5Vin models)	10	20	%
	10-100% load, 5/7Vout (5Vin models)	9	15	%
	10-100% load, 9Vout (5Vin models)	8	10	%
	10-100% load, 12/15Vout (5Vin models)	7	10	%
	10-100% load, 24Vout (5Vin models)	6	10	%
	10-100% load, 5/6Vout (12/15/24Vin models)	7	15	%
	10-100% load, 9Vout (12/15/24Vin models)	6	10	%
	10-100% load, 12Vout (12/15/24Vin models)	5	10	%
	10-100% load, 15Vout (12/15/24Vin models)	4	10	%
10-100% load, 24Vout (12/15/24Vin models)	3	10	%	
Temperature coefficient		\pm 0.02		%/°C
Ripple & Noise*	5Vin models	75	200	mV pk-pk
	Others	50	150	mV pk-pk
Minimum load**		10		%

* Ripple and Noise are measured at 20MHz bandwidth. Please refer to the application note for specific details.

** If the required power is less than 1% of the rated converter output, connect a bleeder resistor in parallel with the load to satisfy the minimum load requirement.

General Specifications				
Parameters	Conditions	Typical	Maximum	Units
Switching frequency	Full load, 5Vin nominal input	220		KHz
	Full load, Others nominal input	260		KHz
Short circuit protection	Continuous, Auto recovery			
Operating temperature	With derating at 71°C, see derating graph	-40 to +105		°C
Storage temperature		-55 to +125		°C

Maximum Case temperature		130		°C
Reflow soldering temperature	Maximum duration 60s when over 217°C		245	°C
Soldering method	IPC/JEDEC J-STD-020D.1.			
Cooling	Free air convection			
Humidity	Non-condensing	>5	95	% RH
Moisture sensitivity level	Level 1			
Case material	Black plastic (flammability to UL 94V-0)			
Weight		1.4		g
Dimensions (L x W x H)		0.52 x 0.45 x 0.28 inches (13.20 x 11.40 x 7.25 mm)		
MTBF	3 500 000 hrs (MIL-HDBK -217F, t=+25°C) / Full Load			
NOTE: All specifications in this datasheet are measured at an ambient temperature of 25°C, humidity<75%, nominal input voltage and at rated output load unless otherwise specified.				

Safety Specifications		
Parameters		
Standards	Information technology Equipment	Design to meet EN62368
	EMC - Conducted and radiated emission	CISPR32 / EN55032, class B with the recommended EMI circuit
	Electrostatic Discharge Immunity	IEC 61000-4-2 Air ±8KV, Contact ±6KV, Criteria B

Derating

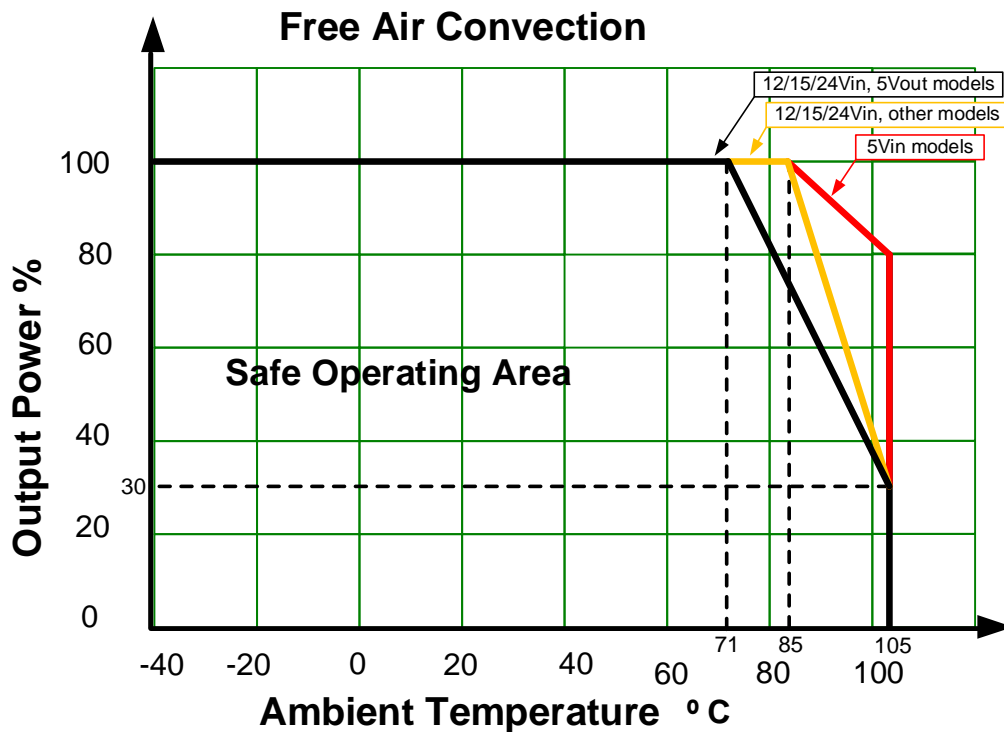

Output voltage tolerance



5Vin, 3.3Vout models

Tolerance Envelope Graph

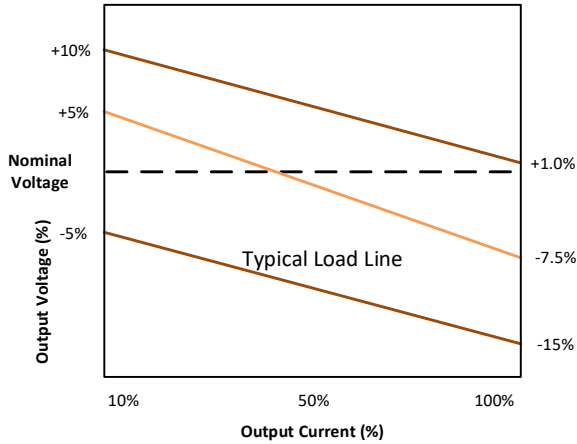

5Vin, other models

Tolerance Envelope Graph

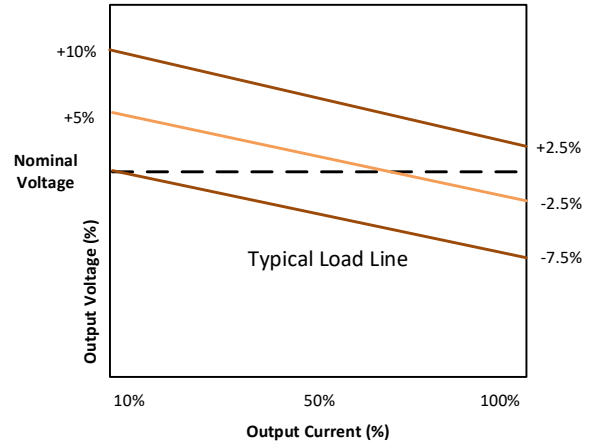

12/15/24Vin models

Tolerance Envelope Graph

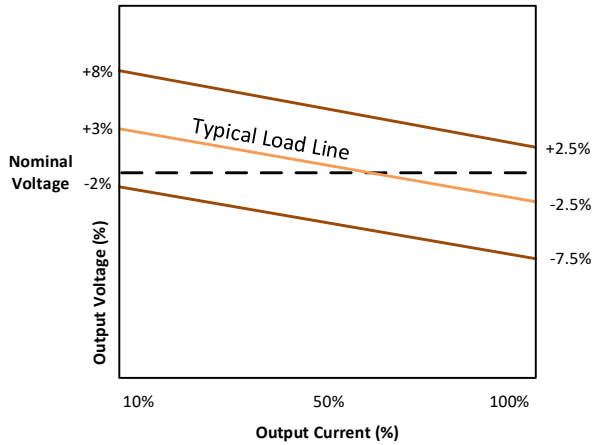

Typical application circuit

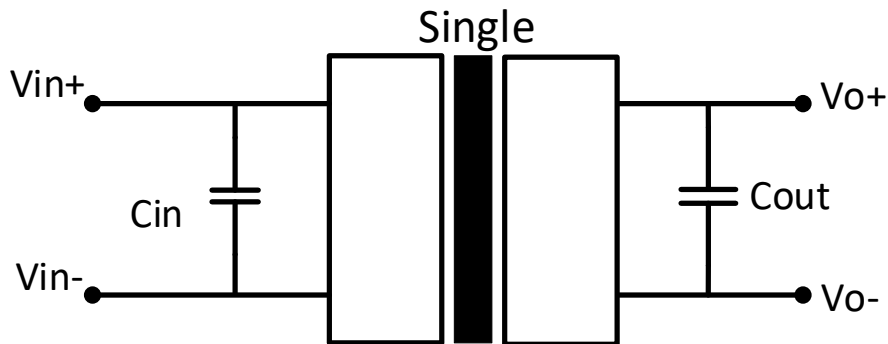

Vin	Cin	12/15/24Vin models		5Vin models	
		Vout	Cout	Vout	Cout
5	4.7μF/16V	3.3V/5V	10μF/10V	3.3V/5V	10μF/16V
12	2.2μF/25V	6V/9V/12V	2.2μF/25V	7V/9V	4.7μF/16V
15	1μF/25V	15V	1μF/25V	12V	2.2μF/25V
24	1μF/50V	24V	0.47μF/50V	15V	1μF/25V
-	-	-	-	24V	0.47μF/50V

EMI Recommended circuit

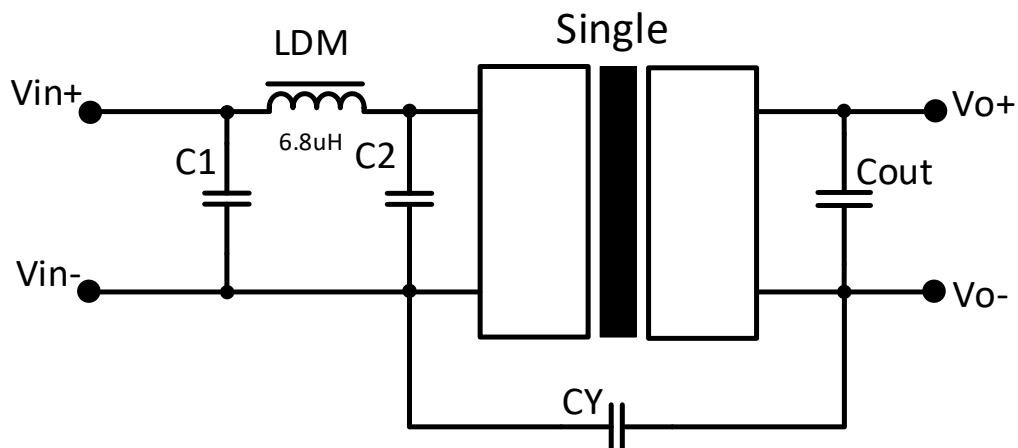

Vin	C1/C2	CY
5V	4.7μF/16V	270pF/2kVdc (1.5kVdc isolation models)
		270pF/4kVdc (3kVdc isolation models)
12V/24V	4.7μF/50V	270pF/2kVdc (1.5kVdc isolation models)
		270pF/3kVdc (3kVdc isolation models)

Dimensions

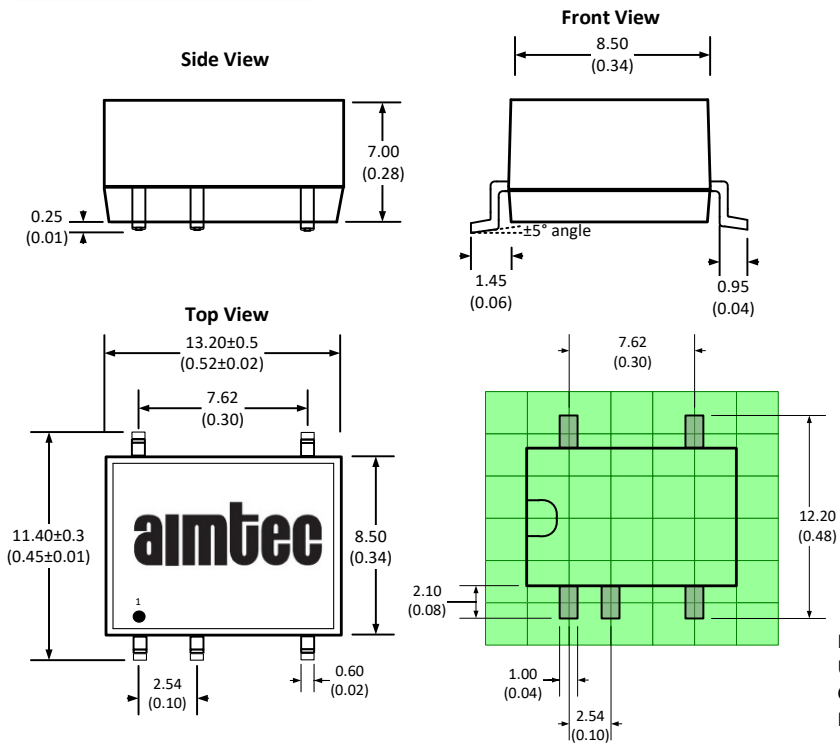

Note:
Unit: mm(inch)
General tolerance: ±0.25 (0.01)
Pin tolerance: ±0.1 (0.004)

Pin Out Specifications	
Pin	Single
1	-V Input
2	+V Input
3	-
4	-V Output
5	+V Output
6	-
7	-
8	NC

Packing Information

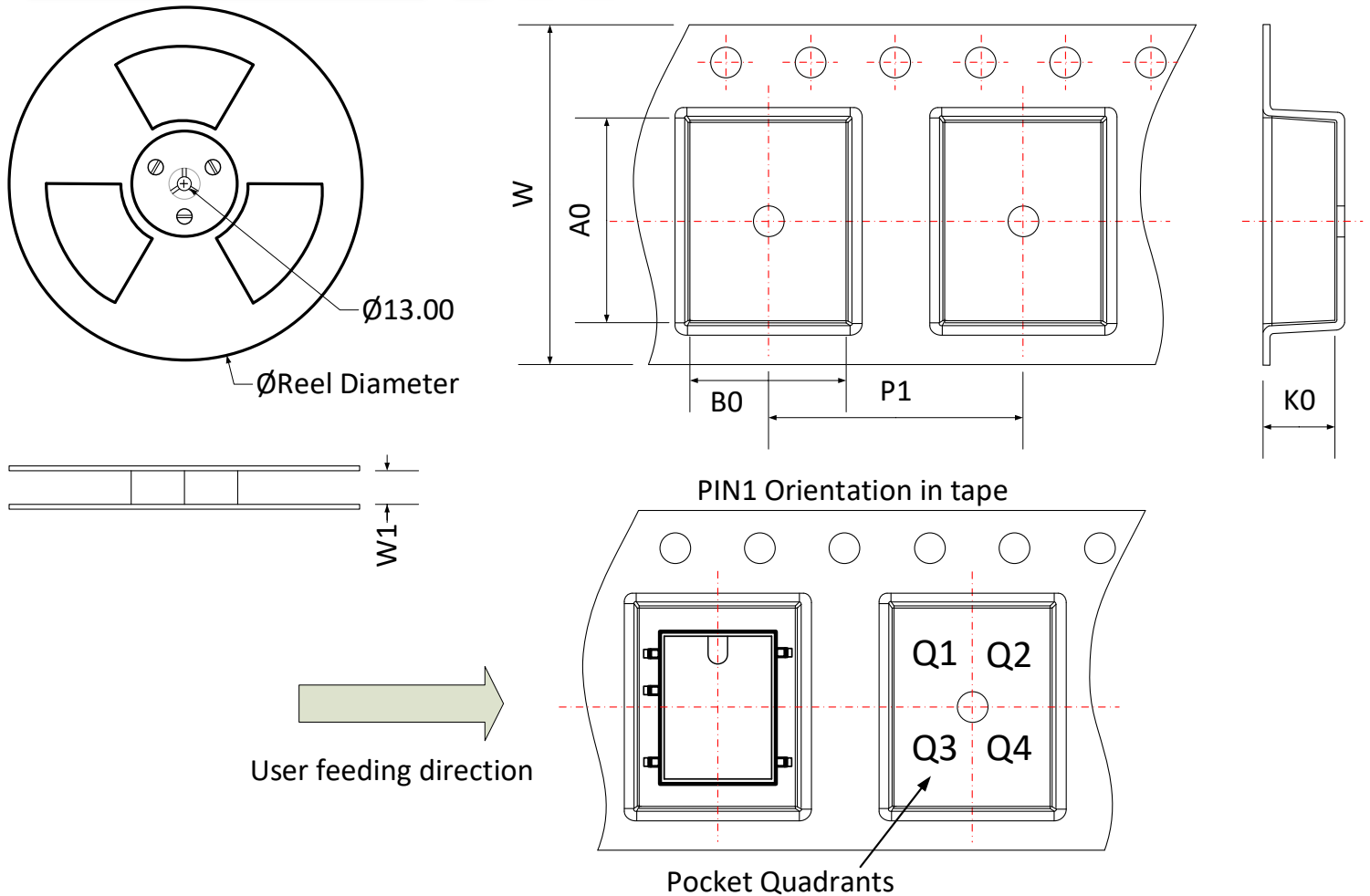

Device	Package Type	Pin	MPQ	Reel Diameter (mm)	Reel Width W1 (mm)	A0	B0	K0	P1	W	P1 Quadrant
AM2LS-JZ	SMD	5	500	330.0	24.5	13.4	11.7	7.5	16.0	24.0	Q1

NOTE: 1. Datasheets are updated as needed and as such, specifications are subject to change without notice. Once printed or downloaded, datasheets are no longer controlled by Aimtec; refer to www.aimtec.com for the most current product specifications. **2.** Product labels shown, including safety agency certifications on labels, may vary based on the date manufactured. **3.** Mechanical drawings and specifications are for reference only. **4.** All specifications are measured at an ambient temperature of 25°C, humidity < 75%, nominal input voltage and at rated output load unless otherwise specified. **5.** Aimtec may not have conducted destructive testing or chemical analysis on all internal components and chemicals at the time of publishing this document. CAS numbers and other limited information are considered proprietary and may not be available for release. **6.** This product is not designed for use in critical life support systems, equipment used in hazardous environments, nuclear control systems or other such applications which necessitate specific safety and regulatory standards other than the ones listed in this datasheet. **7.** Warranty is in accordance with Aimtec's standard Terms of Sale available at www.aimtec.com.