

Click to
ORDER
samples

AM1PS-JZ

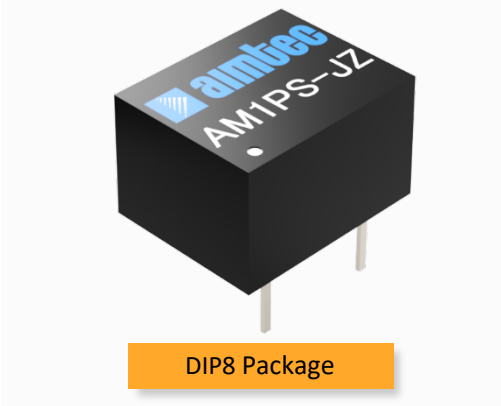

The AM1PS-JZ is a 1W DIP8 DC/DC converter that offers great cost savings thanks to an improved manufacturing process. It also features excellent reliability and performance while offering a standard input voltage range of 3.3-24VDC as well as an output voltage of 3.3-24V. This compact DIP8 design will surely benefit your new system design.

This new series offers great operating temperatures, from -40 to 105°C with full power up to 85°C. Also, an isolation of 1500 or 3000VDC for improved reliability and system safety as well as a great 3,500,000h MTBF come standard.

The AM1PS-JZ is suitable for instrumentation, industrial controls, industrial applications, communication and IoT applications.

Features

- High I/O Isolation of 1500/3000VDC
- Continuous Short circuit protection
- Operating Temp: -40 °C to +105 °C
- Industry standard DIP8 pin-out
- Efficiency up to 85%
- Unregulated output

Summary

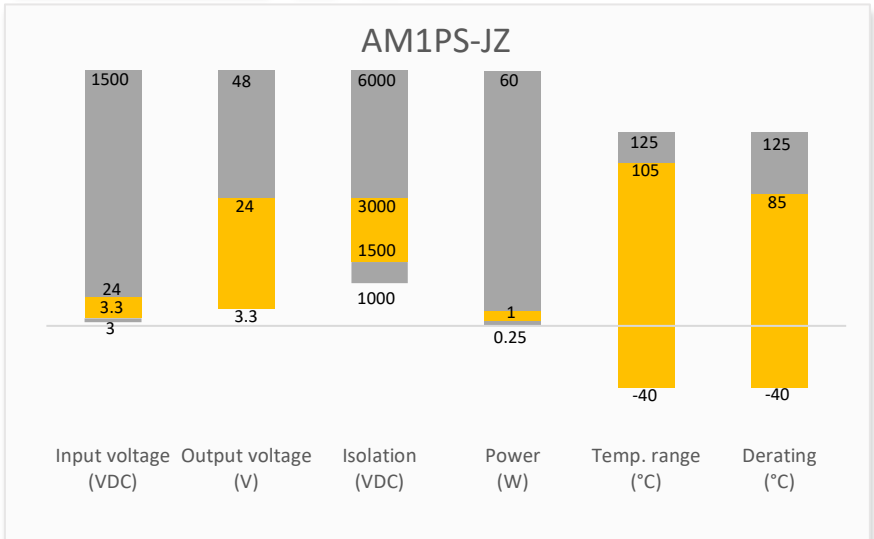

Training



Product Training Video
(click to open)



Press Release

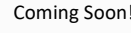

Coming Soon!

Application Notes

Applications



Models & Specifications

Single Output							
Model	Input Voltage (VDC)	Output Voltage (VDC)	Input Current Full No load typ. (mA)	Output Current max min (mA)*	Isolation (VDC)	Maximum capacitive Load (μF)	Efficiency Typ. (%)
AM1PS-0303SJZ ✖	3.3 (2.97-3.63)	3.3	384 / 12	303 / 30	1500	2400	79
AM1PS-0305SJZ ✖	3.3 (2.97-3.63)	5	370 / 12	200 / 20	1500	2400	82
AM1PS-0503SJZ ✖	5 (4.5-5.5)	3.3	270 / 5	303 / 30	1500	2400	74
AM1PS-0505SJZ ✖	5 (4.5-5.5)	5	270 / 5	200 / 20	1500	2400	82
AM1PS-0507SJZ ✖	5 (4.5-5.5)	7.2	241 / 12	139 / 13	1500	1000	80
AM1PS-0509SJZ ✖	5 (4.5-5.5)	9	241 / 12	111 / 12	1500	1000	83
AM1PS-0512SJZ ✖	5 (4.5-5.5)	12	241 / 12	84 / 9	1500	560	83
AM1PS-0515SJZ ✖	5 (4.5-5.5)	15	241 / 18	67 / 7	1500	560	83
AM1PS-0524SJZ ✖	5 (4.5-5.5)	24	241 / 18	42 / 4	1500	220	85
AM1PS-1203SJZ	12 (10.8-13.2)	3.3	112 / 8	303 / 30	1500	2400	75
AM1PS-1205SJZ	12 (10.8-13.2)	5	105 / 8	200 / 20	1500	2400	80
AM1PS-1209SJZ ✖	12 (10.8-13.2)	9	105 / 8	111 / 12	1500	1200	78
AM1PS-1212SJZ	12 (10.8-13.2)	12	105 / 8	83 / 9	1500	560	80
AM1PS-1215SJZ	12 (10.8-13.2)	15	103 / 8	67 / 7	1500	560	81
AM1PS-1224SJZ	12 (10.8-13.2)	24	103 / 8	42 / 5	1500	220	81
AM1PS-1505SJZ ✖	15 (13.5-16.5)	5	83 / 8	200 / 20	1500	2400	80
AM1PS-1509SJZ ✖	15 (13.5-16.5)	9	82 / 8	111 / 12	1500	1200	80
AM1PS-1515SJZ ✖	15 (13.5-16.5)	15	82 / 8	67 / 7	1500	560	81
AM1PS-2403SJZ	24 (21.6-26.4)	3.3	56 / 8	303 / 30	1500	2400	75
AM1PS-2405SJZ	24 (21.6-26.4)	5	53 / 8	200 / 20	1500	2400	79
AM1PS-2409SJZ ✖	24 (21.6-26.4)	9	52 / 8	111 / 12	1500	1200	80
AM1PS-2412SJZ	24 (21.6-26.4)	12	52 / 8	83 / 9	1500	560	81
AM1PS-2415SJZ	24 (21.6-26.4)	15	52 / 8	67 / 7	1500	560	81
AM1PS-2424SJZ	24 (21.6-26.4)	24	52 / 8	42 / 5	1500	220	81
AM1PS-0503SH30JZ	5 (4.5-5.5)	3.3	270 / 5	303 / 30	3000	2400	74
AM1PS-0505SH30JZ	5 (4.5-5.5)	5	270 / 5	200 / 20	3000	2400	82
AM1PS-0507SH30JZ ✖	5 (4.5-5.5)	7.2	241 / 12	139 / 13	3000	1000	80
AM1PS-0509SH30JZ	5 (4.5-5.5)	9	241 / 12	111 / 12	3000	1000	83
AM1PS-0512SH30JZ	5 (4.5-5.5)	12	241 / 12	84 / 9	3000	560	83
AM1PS-0515SH30JZ	5 (4.5-5.5)	15	241 / 18	67 / 7	3000	560	83
AM1PS-0524SH30JZ	5 (4.5-5.5)	24	241 / 18	42 / 4	3000	220	85
AM1PS-1203SH30JZ	12 (10.8-13.2)	3.3	112 / 8	303 / 30	3000	2400	75
AM1PS-1205SH30JZ	12 (10.8-13.2)	5	105 / 8	200 / 20	3000	2400	80
AM1PS-1209SH30JZ ✖	12 (10.8-13.2)	9	105 / 8	111 / 12	3000	1200	78
AM1PS-1212SH30JZ	12 (10.8-13.2)	12	105 / 8	83 / 9	3000	560	80
AM1PS-1215SH30JZ	12 (10.8-13.2)	15	103 / 8	67 / 7	3000	560	81
AM1PS-1224SH30JZ	12 (10.8-13.2)	24	103 / 8	42 / 5	3000	220	81
AM1PS-1505SH30JZ ✖	15 (13.5-16.5)	5	83 / 8	200 / 20	3000	2400	80
AM1PS-1509SH30JZ ✖	15 (13.5-16.5)	9	82 / 8	111 / 12	3000	1200	80
AM1PS-1515SH30JZ ✖	15 (13.5-16.5)	15	82 / 8	67 / 7	3000	560	81
AM1PS-2403SH30JZ	24 (21.6-26.4)	3.3	56 / 8	303 / 30	3000	2400	75
AM1PS-2405SH30JZ	24 (21.6-26.4)	5	53 / 8	200 / 20	3000	2400	79

AM1PS-2409SH30JZ ✖	24 (21.6-26.4)	9	52 / 8	111 / 12	3000	1200	80
AM1PS-2412SH30JZ	24 (21.6-26.4)	12	52 / 8	83 / 9	3000	560	81
AM1PS-2415SH30JZ	24 (21.6-26.4)	15	52 / 8	67 / 7	3000	560	81
AM1PS-2424SH30JZ	24 (21.6-26.4)	24	52 / 8	42 / 5	3000	220	81

* Performance will be degraded if the load is not within the output current range.

Input Specification				
Parameters	Conditions	Typical	Maximum	Units
Filter	Capacitor			
Absolute maximum rating	Maximum duration 1s, 3.3Vin	> -0.7	5	VDC
	Maximum duration 1s, 5Vin	> -0.7	9	VDC
	Maximum duration 1s, 12Vin	> -0.7	18	VDC
	Maximum duration 1s, 15Vin	> -0.7	21	VDC
	Maximum duration 1s, 24Vin	> -0.7	30	VDC
Input reflected ripple current	3.3Vin models	30		mA
	Other models	15		mA

Isolation Specification				
Parameters	Conditions	Typical	Maximum	Units
Tested I/O voltage	60 sec, leakage ≤ 1mA	>1500		VDC
	60 sec, leakage ≤ 1mA for H30 models	>3000		VDC
Resistance	500VDC	>1000		MΩ
Capacitance	100kHz/0.1V	20		pF

Output Specification				
Parameters	Conditions	Typical	Maximum	Units
Voltage accuracy	See output voltage tolerance	10	16	%
Line regulation	Per 1% Vin change, 3.3Vout models		1.5	%
	Per 1% Vin change, other models		1.2	%
Load regulation	10-100% load, 3.3Vout models		20	%
	10-100% load, 5/7.2Vout models		15	%
	10-100% load, other models		10	%
Ripple & Noise*	24Vout and 3.3Vin models	50	100	mV pk-pk
	other models	30	75	mV pk-pk
Temperature coefficient		±0.02		%/°C

* Ripple and Noise are measured at 20MHz bandwidth. Please refer to the application note for specific details.

General Specifications				
Parameters	Conditions	Typical	Maximum	Units
Switching frequency	Full load, nominal input, 3.3Vin models	220		KHz
	Full load, nominal input, 5Vin, 1.5KV isolation models	300		KHz
	Full load, nominal input, 5Vin, 3KV isolation models	270		KHz
	Full load, nominal input, other models	260		KHz
Short circuit protection	Continuous, Auto recovery			
Operating temperature	With derating	-40 to +105		°C
Storage temperature		-55 to +125		°C

Case temperature rise	Ta = 25°C, 5Vin, 5/7.2/9/12/15/24Vout models	15		°C
	Ta = 25°C, other models	25		°C
Manual soldering temperature	1.5mm away from case, duration ≤ 10sec, 3.3/5Vin models		300	°C
	1.5mm away from case, duration ≤ 10sec, other models		260	°C
Cooling	Free air convection			
Humidity	Non-condensing	>5	95	% RH
Vibration	10-150Hz, 5G, 0.75mm, along all axis			
Case material	Black plastic (flammability to UL 94V-0)			
Weight		1.8		g
Dimensions (L x W x H)	0.50 x 0.40 x 0.32 inches (12.70 x 10.16 x 8.20 mm)			
MTBF	3 500 000 hrs (MIL-HDBK -217F, t=+25°C) / Full Load			
NOTE: All specifications in this datasheet are measured at an ambient temperature of 25°C, humidity<75%, nominal input voltage and at rated output load unless otherwise specified.				

Safety Specifications		
Parameters		
Agency approval	cULus UL62368-1 (With exception of models marked with ✖)	
Standards	Information technology equipment	Design to meet IEC/EN62368-1
	EMC - Conducted and radiated emission	CISPR32 / EN55032, class B with the recommended EMI circuit
	Electrostatic Discharge Immunity	IEC 61000-4-2 Air ±8KV, Contact ±4KV, Criteria B for 5Vin, 3KV isolation models IEC 61000-4-2 Air ±8KV, Contact ±6KV, Criteria B for other models

Derating

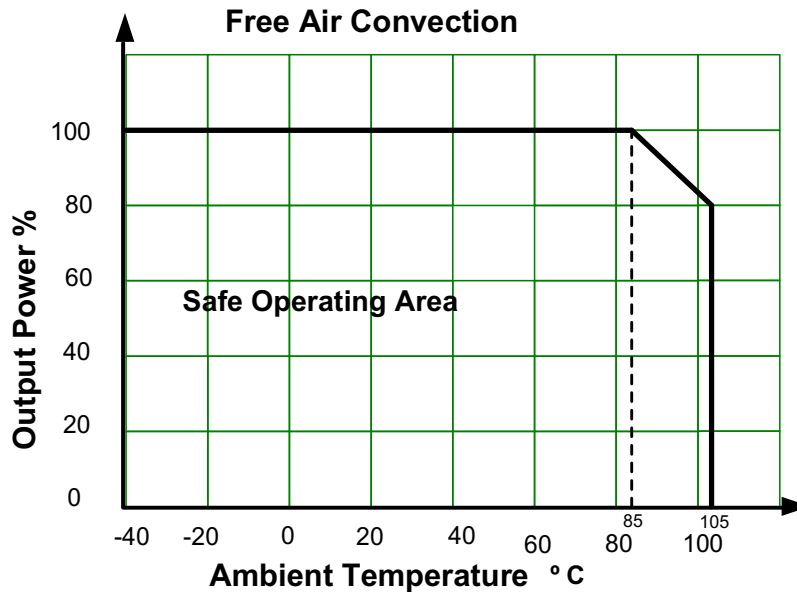

Output voltage tolerance

AM1PS-0303SJZ

Tolerance Envelope Graph

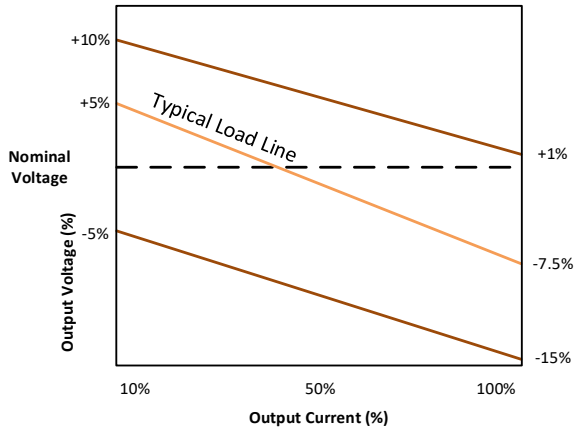

5/12/15/24Vin, 3.3Vout models

Tolerance Envelope Graph

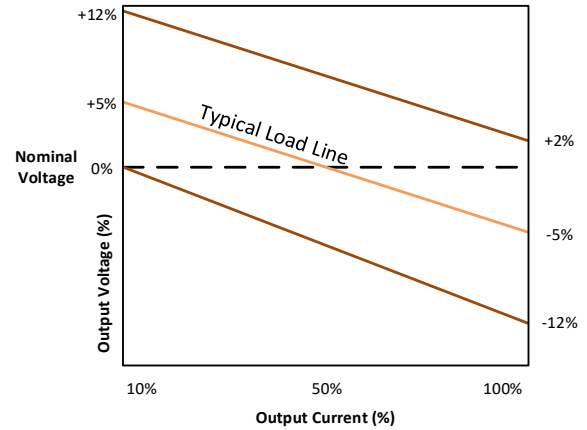

AM1PS-0305SJZ and 5Vin, other models

Tolerance Envelope Graph

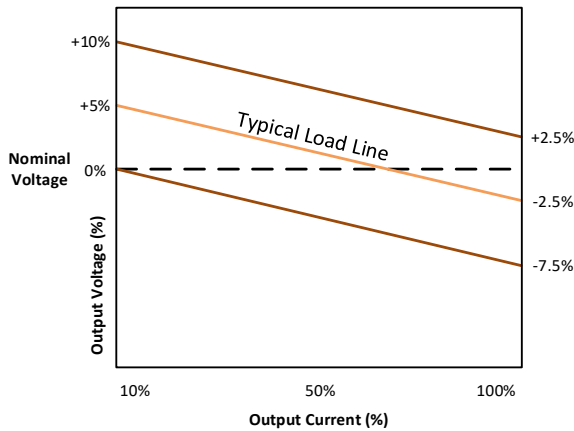

12/15/24Vin, other models

Tolerance Envelope Graph

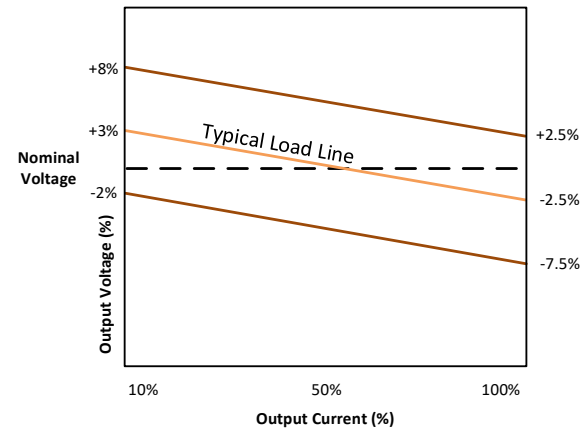

Typical application circuit

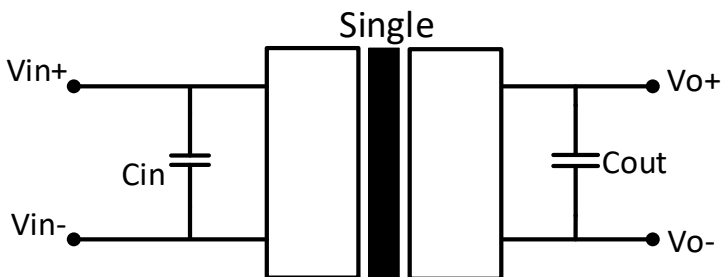

Vin	Cin
3.3V	10 μ F
5V	4.7 μ F
12/15V	2.2 μ F
24V	1 μ F

Vout	Cout
3.3/5/7.2V	10 μ F
9V (5Vin series)	2.2 μ F
9V (12/15/24Vin series)	4.7 μ F
12V	2.2 μ F
15/24V	1 μ F

Recommended EMI circuit

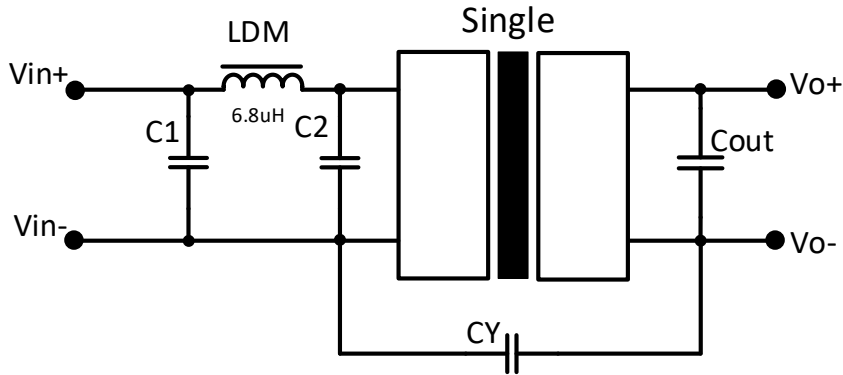

3.3Vin models		
Vout	C1/C2	CY
All	4.7μF/16V	270pF/2kVdc

5Vin, 1.5KV isolation models		
Vout	C1/C2	CY
3.3/5/7.2/9V	4.7μF/25V	100pF/2kVdc
12/15/24V	4.7μF/25V	1nF/2kVdc

5Vin, 3KV isolation models		
Vout	C1/C2	CY
3.3/5/7.2/9V	4.7μF/25V	-
12/15/24V	4.7μF/25V	1nF/4kVdc

12/15/24Vin models		
Isolation	C1/C2	CY
1.5KV	4.7μF/50V	270pF/2kVdc
3KV	4.7μF/50V	270pF/3kVdc

Dimensions

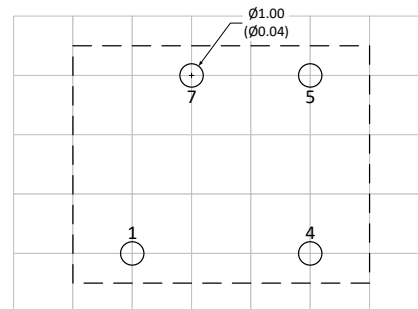
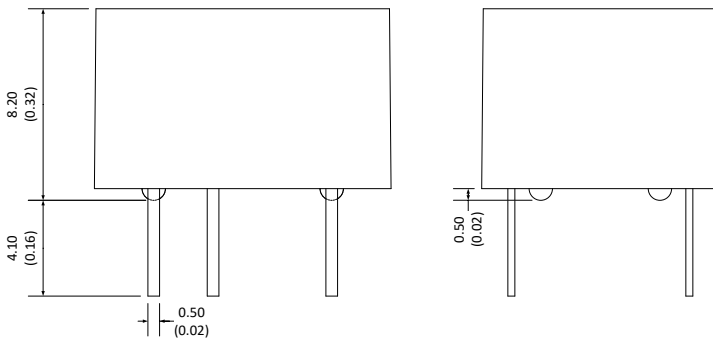

Grid size: 2.54*2.54mm

Pin Out Specifications	
Pin	Single output
1	-V Input
4	+V Input
5	+V Output
7	-V Output

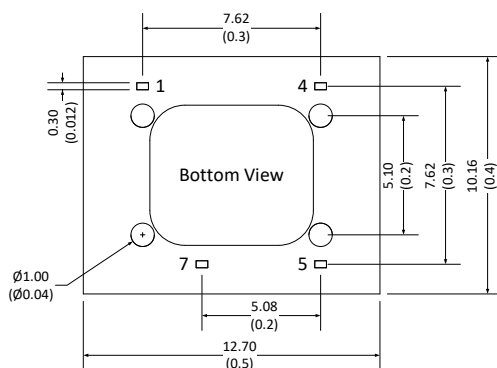

Note:
Unit: mm(inch)
General tolerance: ±0.25 (0.01)
Pin tolerance: ±0.1 (0.004)

NOTE: 1. Datasheets are updated as needed and as such, specifications are subject to change without notice. Once printed or downloaded, datasheets are no longer controlled by Aimtec; refer to www.aimtec.com for the most current product specifications. **2.** Product labels shown, including safety agency certifications on labels, may vary based on the date manufactured. **3.** Mechanical drawings and specifications are for reference only. **4.** All specifications are measured at an ambient temperature of 25°C, humidity<75%, nominal input voltage and at rated output load unless otherwise specified. **5.** Aimtec may not have conducted destructive testing or chemical analysis on all internal components and chemicals at the time of publishing this document. CAS numbers and other limited information are considered proprietary and may not be available for release. **6.** This product is not designed for use in critical life support systems, equipment used in hazardous environments, nuclear control systems or other such applications which necessitate specific safety and regulatory standards other than the ones listed in this datasheet. **7.** Warranty is in accordance with Aimtec's standard Terms of Sale available at www.aimtec.com.