



AMEL10-277HAVZ



Encapsulated

AMEL10-277HAVZ series is an efficient 10W AC-DC power supply module. Offering a commercial input voltage range of 85-305VAC, output voltage ranges from 3.3-24V, low power consumption, high efficiency and high reliability.

This new series offers great operating temperatures, from -40°C to 85°C with full power up to 50°C and features an isolation of 4000VAC for improved reliability and system safety. Furthermore, a high MTBF of 1,000,000h, output short circuit protection (OSCP), output over-current protection (OCP) and an output over-voltage protection (OVP) come standard with the series.

The AMEL10-277HAVZ is suitable for grid power, instrumentation, industrial controls, communication, and civil applications.

Features

- Universal Input: 85 - 305VAC/100 - 430VDC
- Operating Temp: -40 °C to +85 °C
- High isolation voltage: 4000VAC
- Low ripple & noise, 150mV(p-p), max.
- Output short circuit, over-current, over-voltage protection
- Regulated Output
- Efficiency up to 85%
- Agency approvals: IEC/EN62368, EN60335, EN61558
- Designed to meet: UL62368-1



Summary

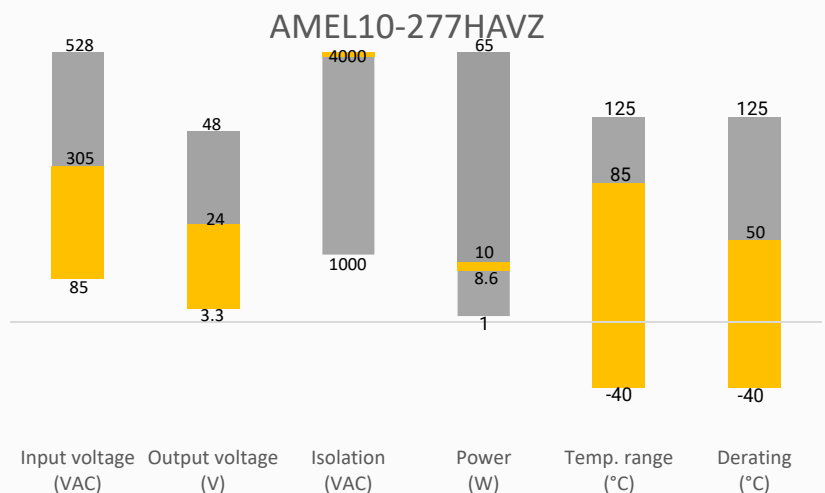

Training



Product Training Video
(click to open)



Press Release

Coming Soon!

Application Notes

Applications



Power Grid



Industrial



Telecom



Instrumentation

Models & Specifications

Single Output

Model	Input Voltage (VAC/Hz)	Input Voltage (VDC)	Max Output wattage (W)	Output Voltage (V)	Output Current max (A)	Maximum capacitive load (μ F)	Efficiency @ 230VAC Typ. (%)
AMEL10-3S277HAVZ	85-305/47-63	100-430	8.6	3.3	2.6	3000	74
AMEL10-5S277HAVZ	85-305/47-63	100-430	10	5	2	3000	79
AMEL10-9S277HAVZ	85-305/47-63	100-430	10	9	1.1	1000	81
AMEL10-12S277HAVZ	85-305/47-63	100-430	10	12	0.83	820	84
AMEL10-15S277HAVZ	85-305/47-63	100-430	10	15	0.66	680	84
AMEL10-24S277HAVZ	85-305/47-63	100-430	10	24	0.41	220	85

Input Specifications

Parameters	Conditions	Typical	Maximum	Units
Input current	115VAC		230	mA
	230VAC		150	mA
Inrush current	115VAC	25		A
	230VAC	40		A
Leakage	277VAC, 50Hz		0.1	mA RMS
Fuse	2A/300V, Slow blow			

Output Specifications

Parameters	Conditions	Typical	Maximum	Units
Voltage accuracy		± 2		%
Line regulation	Full load	± 0.5		%
Load regulation	0-100% load	± 1		%
Ripple & Noise*	20MHz bandwidth	50	150	mV p-p
Start-up time		1		S
Hold up time	115VAC	8		ms
	230VAC	40		ms

* Ripple and Noise are measured at 20MHz bandwidth with a 10 μ F electrolytic capacitor and a 1 μ F ceramic capacitor. Please refer to the application note for specific details.

Isolation Specification

Parameters	Conditions	Typical	Maximum	Units
Tested I/O voltage	60 sec, leakage \leq 5mA	4000		VAC
Resistance	500VDC	>100		M Ω

General Specifications

Parameters	Conditions	Typical	Maximum	Units
Protection class	Class II			
Over current protection	Auto recovery	≥ 110		% of Iout
Over voltage protection	3.3, 5Vout, voltage clamp, hiccup		7.5	VDC

	9Vout, voltage clamp, hiccup		15	VDC
	12, 15Vout, voltage clamp, hiccup		20	VDC
	24Vout, voltage clamp, hiccup		30	VDC
Short circuit protection	Hiccup, Continuous, Auto recovery			
Switching Frequency		65		KHz
Operating altitude			5000	m
Operating temperature	See derating graph	-40 to +85		°C
Storage temperature		-40 to +85		°C
Reflow soldering temperature	Duration 5 - 10s	260		°C
Manual soldering temperature	Duration 3 - 5s	360		°C
No-load power consumption	230VAC	0.1		W
Power Derating	-40 °C to -25 °C, 85VAC to 110VAC, 9/12/15/24Vout	2.67		%/°C
	-40 °C to -20 °C, 85VAC to 110VAC, 3.3/5Vout	2		%/°C
	+50 °C to +85 °C, 3.3/5Vout	1.71		%/°C
	+55 °C to +85 °C, 9/12/15/24Vout	1.67		%/°C
	85VAC to 115VAC	0.83		%/VAC
	277VAC to 385VAC	0.71		%/VAC
	2000 - 5000m	6.7		%/km
Temperature coefficient		±0.02		%/°C
Cooling	Free air convection			
Humidity	Non-condensing		95	% RH
Case material	Plastic (flammability to UL 94V-0)			
Weight		40		g
Dimensions (L x W x H)	1.58 x 1.00 x 0.83 inches (40.00 x 25.40 x 21.00 mm)			
MTBF	> 1 000 000 hrs (MIL-HDBK -217F, t=+25°C)			
NOTE: All specifications in this datasheet are measured at an ambient temperature of 25°C, humidity<75%, nominal input voltage and at rated output load unless otherwise specified.				

Safety Specifications	
Parameters	
Agency Approvals	IEC/EN62368, EN60335, EN61558
Standards	Designed to meet UL62368
	EMC - Conducted and radiated emission CISPR32 / EN55032, class B with recommended EMC circuit

Derating

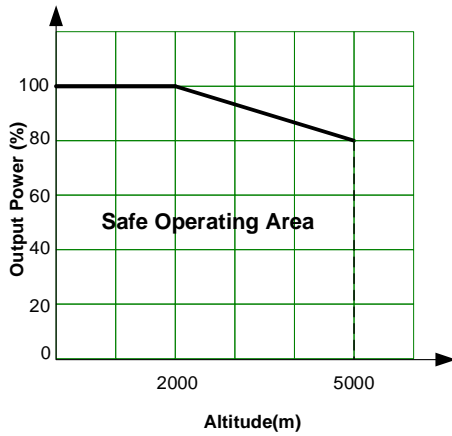
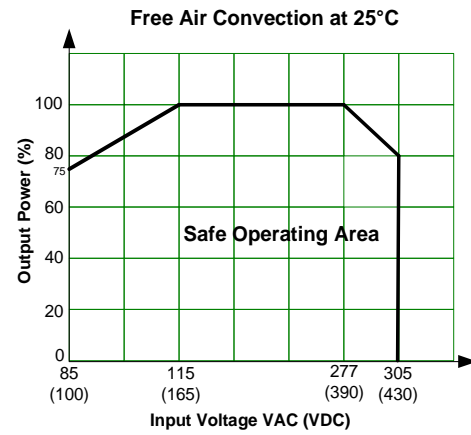
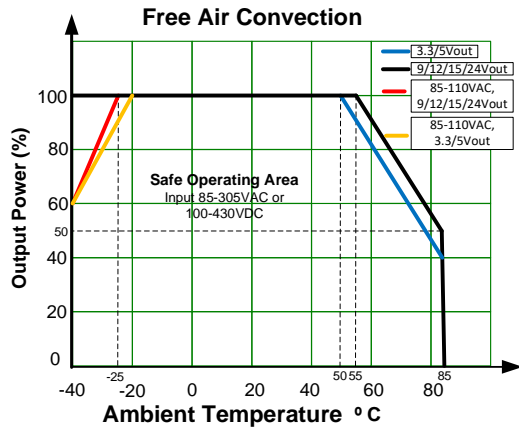

Typical Application Circuit

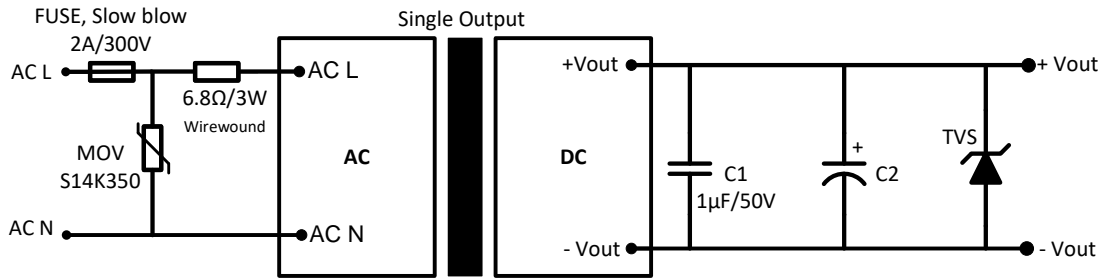

Model	C2	TVS
3.3, 5Vout	220μF/16V	SMBJ7.0A
9Vout	100μF/35V	SMBJ12A
12, 15Vout	100μF/25V	SMBJ20A
24Vout	100μF/35V	SMBJ30A

For filtering components:

The input fuse is recommended to use slow blow type. Choose capacitors with at least 20% voltage margin. The C2 capacitor is recommended to use electrolytic type with high frequency and low ESR rating. The C1 capacitor is recommended to use ceramic type for filtering high-frequency noise.

Recommended EMC Circuit

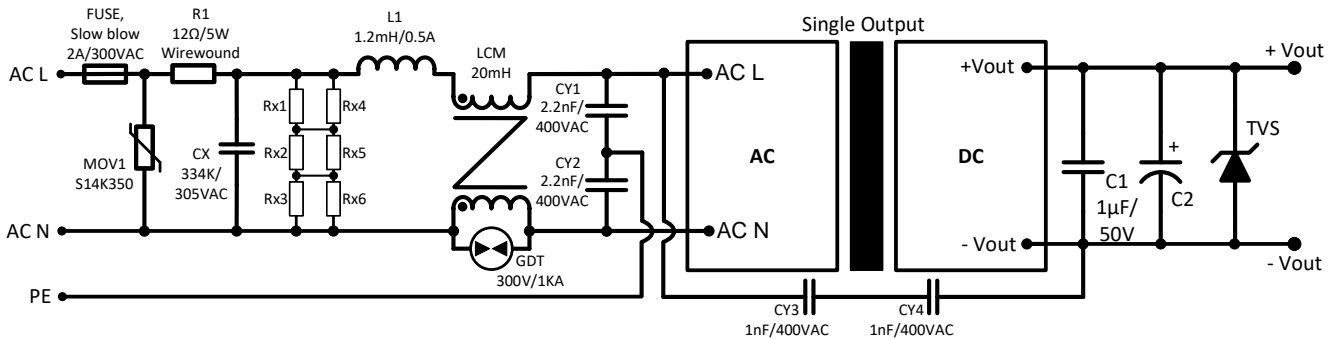

Rx1, Rx2, Rx3, Rx4, Rx5, Rx6
1.5MΩ/150VDC

Dimensions

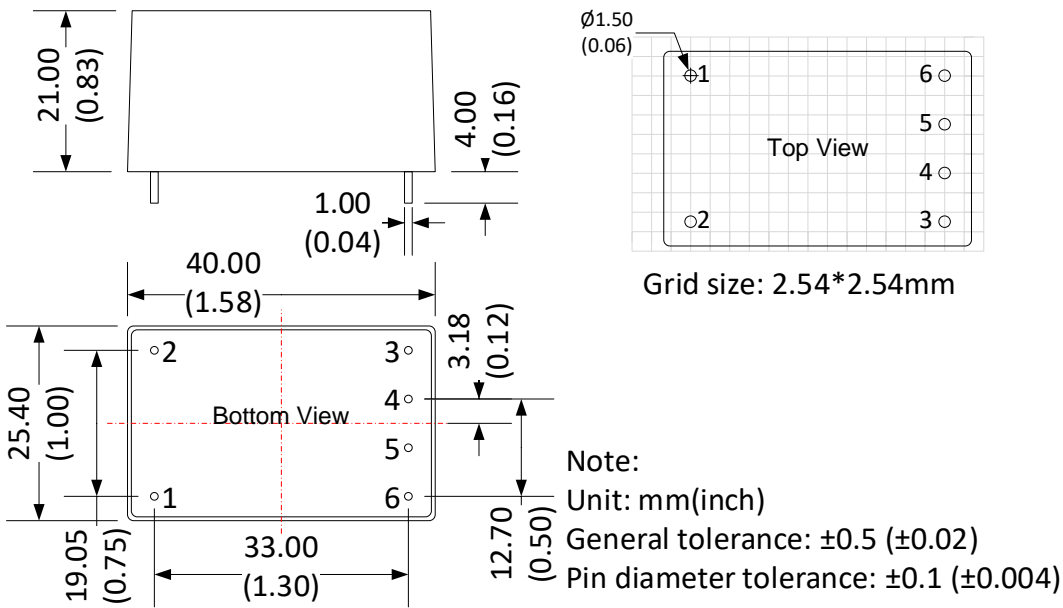

Pin Output Specifications	
Pin	Function
1	AC Input (L)
2	AC Input (N)
3	No Pin
4	+V Output
5	No Pin
6	-V Output

NOTE: 1. Datasheets are updated as needed and as such, specifications are subject to change without notice. Once printed or downloaded, datasheets are no longer controlled by Aimtec; refer to www.aimtec.com for the most current product specifications. 2. Product labels shown, including safety agency certifications on labels, may vary based on the date manufactured. 3. Mechanical drawings and specifications are for reference only. 4. All specifications are measured at an ambient temperature of 25°C, humidity<75%, nominal input voltage and at rated output load unless otherwise specified. 5. Aimtec may not have conducted destructive testing or chemical analysis on all internal components and chemicals at the time of publishing this document. CAS numbers and other limited information are considered proprietary and may not be available for release. 6. This product is not designed for use in critical life support systems, equipment used in hazardous environments, nuclear control systems or other such applications which necessitate specific safety and regulatory standards other the ones listed in this datasheet. 7. Warranty is in accordance with Aimtec's standard Terms of Sale available at www.aimtec.com.